

MODEL 960 Series

Pulse Oximeter with Waveform
Non-Invasive Blood Pressure
Temperature & Built-in Printer Option

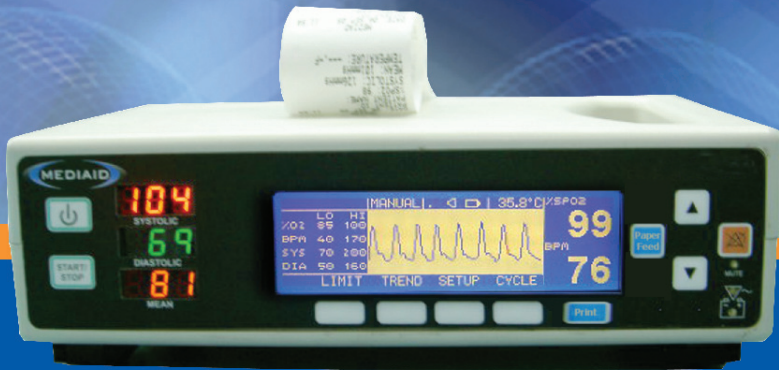

MEDIAID INC.

17517 Fabrica Way Suite H
Cerritos, CA 90703 USA
(Tel) 714-367-2848 (Fax) 714-367-2852
Email: info@mediaidinc.com
Website: www.mediaidinc.com

MODEL 960 Series

User's Manual



MEDIAID INC.

17517 Fabrica Way Suite H
Cerritos, CA 90703 USA
(Tel) 714-367-2848 (Fax) 714-367-2852
E-mail: info@mediaidinc.com
Website: www.mediaidinc.com



MDSS GmbH
Schiffgraben 41
30175 Hannover, Germany

TABLE OF CONTENTS

Chapter 1: *Safety Information*

1.1 GENERAL SAFETY INFORMATION	1
--------------------------------------	---

Chapter 2: *Introduction*

2.1 INTENDED USE	3
2.2 GENERAL OPERATING PRINCIPLES AND CONDITIONS	3
Principle of SpO ₂ Measurement	3
Principle of Blood Pressure Measurement	3
Principle of Temperature Measurement	3

Chapter 3: *Controls, Indicators and Symbols*

3.1 DISPLAYS, CONTROLS, INDICATORS AND CONNECTORS	5
3.2 SYMBOLOGY AND MARKINGS	7
3.3 DESCRIPTION OF CONTROLS AND CONNECTORS	8
3.4 ALARM LEVELS	11
3.5 DESCRIPTION OF AUDIBLE ALARMS	11

Chapter 4: *Setup*

4.1 UNPACKING AND INSPECTION	13
4.2 LIST OF COMPONENTS	13
4.3 MONITOR SETUP	13

Chapter 5: *Detailed Operating Instructions*

5.1 GENERAL PRECAUTIONS	15
5.2 SPO ₂ MEASUREMENTS	16
5.3 SELECTING A SENSOR	16
5.4 BIOCOMPATIBILITY TESTING	17
5.5 PERFORMANCE CONSIDERATIONS	17

5.6 NIBP MEASUREMENTS	19
Manual NIBP Mode	19
Automatic NIBP Mode	20
Adjustment of the Inflation Pressure	21
Suspension of NIBP Measurement	21
NIBP Pressure Limit Fail Safety	21
Cuff Inflation Time	21
5.7 START AND STOP FUNCTIONS	21
5.8 TEMPERATURE MEASUREMENTS	22
5.9 PRINTER (OPTIONAL)	22
Setting Up a Customized Name on the Printout	22
Manual Mode Printing	23
Automatic Mode Printing	23
Paper Feed Key	24
Loading the Printer Paper	24
5.10 FUNCTIONAL TEST MODE (DIAGNOSTIC MODE)	26
5.11 ADJUSTABLE SETTINGS	28
Pulse Beep Volume	28
Setting Pulse Beep Frequency	28
Alarm Mute	28
5.12 MENU	30
5.13 LIMITS	31
Overview	31
Viewing Current Alarm Limits	31
Changing Alarm Limits	31
Adult Default Limits	32
Neonate Default Limits	33
5.14 SETUP	34
Alarm Volume	34
Contrast	34
Patient Type Setting	34
Language	34
Date	35
Time	35
Printer Mode	36
Power Save Mode	36
Temperature Scale	36
5.15 PLETH / BLIP VIEW	37
5.16 TREND	37
Tabular Format	37
Graphical Format	38
Trend Delete	40
5.17 NIBP CYCLE TIME	40
5.18 NURSE CALL (OPTIONAL FEATURE)	41

- 5.19 ANALOG OUTPUT (OPTIONAL FEATURE) 42**
- 5.20 DEFAULT SETTINGS 42**
- 5.21 BATTERY OPERATION 44**
 - Low Battery Indicator 44
- 5.22 DISPOSAL OF DEVICE COMPONENTS 44**
- 5.23 PERFORMANCE CONSIDERATIONS 45**

Chapter 6: *Troubleshooting and Maintenance*

- 6.1 TROUBLESHOOTING 47**
 - Error Codes 47
- 6.2 STATUS MESSAGES 48**
 - SpO₂ Messages 48
 - NIBP Messages 48
 - Printer Messages 51
 - Temperature Messages 51
 - General Messages 51
- 6.3 SUGGESTED CORRECTIVE ACTIONS 52**
- 6.4 EMI (ELECTROMAGNETIC INTERFERENCE) 53**
- 6.5 OBTAINING TECHNICAL ASSISTANCE 54**
 - Returning the Model 960 Series 54
- 6.6 MAINTENANCE 55**
 - Service 55
 - Periodic Safety Checks 55
 - Performance Verification 55
 - Cleaning 55

Chapter 7: *Specifications and Performance Requirements*

- 7.1 PERFORMANCE 57**
 - SpO₂ Performance Requirements 57
 - NIBP Performance Requirements 57
 - Temperature Performance Requirements 59
 - Printer Performance Requirements 59
- 7.2 ELECTRICAL 59**
- 7.3 ENVIRONMENTAL CONDITIONS 60**
- 7.4 PHYSICAL CHARACTERISTICS 60**
- 7.5 COMPLIANCE 60**

Chapter 8: *Data Port Protocol*

8.1 DATA PORT PROTOCOL 61
8.2 SERIAL DATA TRANSMISSION (OPTIONAL FEATURE) 62
8.3 NURSE CALL (OPTIONAL FEATURE) 63
8.4 ANALOG OUTPUTS (OPTIONAL FEATURE) 64

Chapter 9: *Principles of Operation*

9.1 OXIMETRY OVERVIEW 65
 How Pulse Oximeters Work 66
 Calibration of Pulse Oximeters 67
 Validation of Accuracy 67
 Clinical Use of Pulse Oximetry 68

Chapter 10: *Mediaid Inc. Warranty Information*

10.1 WARRANTY INFORMATION 69
 Application of Warranty 69
 What is covered by this Warranty? 69
 What Mediaid will do to correct the problems? 69
10.2 OWNER’S REGISTRATION 70
10.3 PRODUCT INFORMATION 70
WARRANTY REGISTRATION FORM 71

Tables

Table 1: Medicaid Sensors	17
Table 2: Factory Default Settings (Large)	42
Table 3: Factory Default Settings (Small)	43
Table 4: Error Codes and Messages	47
Table 5: SpO ₂ Messages	48
Table 6: NIBP Messages	48, 49, 50
Table 7: Printer Messages	51
Table 8: Temperature Messages	51
Table 9: General Messages	51
Table 10: Data Port Pinouts Table	61
Table 11: Serial Data Communication Format (Model 960 Series to system)	62
Table 12: Bit Specification of Status Byte	62
Table 13: Offline Trend Data Command Format	63
Table 14: Analog Pinouts	64

Figures

Figure 1: Model 960 Series Front Panel Display	5
Figure 2: Model 960 Series Rear Panel	6
Figure 3: Model 960 Series Left Side Panel	6
Figure 4: Printer tray open	24
Figure 5: Platten direction	25
Figure 6: Platten removed	25
Figure 7: Platten fixing	25
Figure 8: Menu Structure	30
Figure 9: SpO ₂ , BPM and Temp Alarm Limits Setting	31
Figure 10: NIBP Alarm Limits Setting	32
Figure 11: Alarm Volume, Contrast, Patient Type, Language Settings	35
Figure 12: Date, Time, Print and Power Save Mode Settings	36
Figure 13: Pleth View	37
Figure 14: Blip View	37
Figure 15: Tabular Trend	38
Figure 16: SpO ₂ and BPM Graphical Trend	38
Figure 17: Systolic and Diastolic Graphical Trend	39
Figure 18: Mean and BPM Graphical Trend	39
Figure 19: Temperature and BPM Graphical Trend	39
Figure 20: NIBP Cycle Time and Initial Inflate Settings	41
Figure 21: Principles of Pulse Oximetry	65
Figure 22: Light Absorption	66
Figure 23: Varying Absorption by (HbO ₂) & (Hb)	67
Figure 24: Pleth Amplitude at 660nm & 910 nm	67
Figure 25: Mediaid by Hemoximeter	68
Figure 26: Competitor by Hemoximeter	68

Chapter 1:

SAFETY INFORMATION

General Safety Information

1.1 GENERAL SAFETY INFORMATION

This section contains important safety information related to general use of the Model 960 Series Vital Signs Monitor. Other important safety information appears throughout the manual in sections that relate specifically to the precautionary information.

Important! Before using the monitor, the user should become thoroughly familiar with the information in this manual and with all information included with the sensor.

WARNING: Explosion hazard. Do not use the Model 960 Series monitor in the presence of flammable anesthetics or gases.

WARNING: The Model 960 Series is a prescription device and is to be operated by qualified personnel only.

WARNING: The use of equipment is restricted to one patient at a time.

WARNING: Monitor readings and pulse signal can be affected by certain ambient environmental conditions, sensor application errors, and certain patient conditions. See the appropriate sections of the manual for specific safety information.

WARNING: A Blood pressure measurement reading can be affected by the position of the patient, and his/her physiological condition as well as other factors, such as patient movement.

WARNING: Chemicals from broken LCD display panel are toxic when ingested. Use caution when handling a Monitor with a broken display panel.

WARNING: Use accessories specified by our company only, otherwise; the device may not function normally.

WARNING: The system may not meet its performance specifications if stored or used outside the specified temperature and humidity ranges.

SAFETY INFORMATION

Caution: Follow local governing ordinances and recycling instructions regarding disposal or recycling of device components, including batteries.

Caution: When connecting the Model 960 Series to any instrument, verify proper operation before clinical use. Both the Model 960 Series and the instrument connected to it must be grounded properly. Accessory equipment connected to the monitor's data interface must be certified according to IEC Standard 950 for data-processing equipment or IEC Standard 60601-1 for electro medical equipment. All of these combinations configure a medical system and are therefore responsible for ensuring that the system complies with the requirements of system standard IEC Standard 60601-1 and the electromagnetic compatibility system standard IEC Standard 60601-1-2.

The Model 960 Series accuracy may degrade if it is connected to secondary I/O devices when the instrument is not connected to earth reference.

To ensure accurate readings, consider the environment conditions that are present and the condition of the patient. See the appropriate sections of the manual for specific safety information related to these conditions.

Chapter 2:

INTRODUCTION

Intended Use

General Operating Principles and Conditions

2.1 INTENDED USE

The Model 960 Series is a portable monitor intended for use as a continuous noninvasive monitoring of functional oxygen saturation of arterial hemoglobin (SpO₂), pulse rate, blood pressure and temperature. The intended patient population comprises adult, pediatric and neonatal. The intended environments of use are hospitals, intra-hospital transport environments and home care.

The Model 960 Series is for prescription use only. Hospital use typically covers areas such as general care floors, operating rooms, special procedure areas, intensive and critical care areas within the hospital plus hospital-type facilities such as surgical centers, sub-acute centers, special nursing facilities and sleep labs, outside of the hospital. Intra-hospital transport includes transport of a patient within the hospital or hospital-type facility.

WARNING: The Model 960 Series is intended only as an adjunct in patient assessment. It must be used in conjunction with clinical signs and symptoms.

2.2 GENERAL OPERATING PRINCIPLES AND CONDITIONS

Principle of SpO₂ Measurement

The Model 960 Series measures functional oxygen saturation in the blood. SpO₂ measurement works by applying a sensor to a pulsating arteriolar vascular bed, such as a finger or toe. The sensor contains a dual light source and a photo detector.

Bone, tissue, pigmentation and venous vessels normally absorb a constant amount of light over time. The arteriolar bed normally pulsates and absorbs variable amounts of light during the pulsations. The ratio of light absorbed is translated into a measurement of functional oxygen saturation (SpO₂).

Since the measurement of SpO₂ is dependent upon light from the sensor, excessive ambient light can interfere with this measurement.

Specific information about ambient environment conditions, sensor application and patient conditions is contained throughout this manual.

Principle of Blood Pressure Measurement

Model 960 Series uses the oscillometric method to measure the blood pressure.

Principle of Temperature Measurement

Model 960 Series uses high precision NTC thermistor based temperature measurement. All the monitors are factory calibrated to meet EN 12470-4 accuracy requirements.



Chapter 3:

CONTROLS, INDICATORS AND SYMBOLS

Displays, Controls, Indicators and Connectors

Symbology and Markings

Description of Controls, Displays, Indicators and Connectors

Alarm Levels

Description of Audible Alarms

3.1 DISPLAYS, CONTROLS, INDICATORS AND CONNECTORS

Figure 1, 2 and 3 show the front, rear and side views of the Model 960 Series and identify displays, controls and connectors.

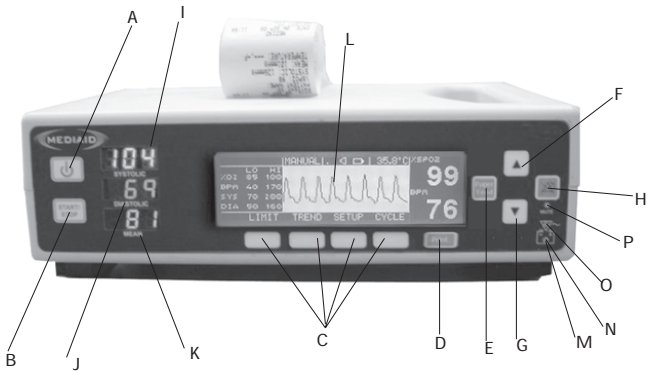

Figure 1 : Model 960 Series Front Panel Display

A	Power On/Off Key	I	Systolic Display
B	Start/Stop Key (NIBP)	J	Diastolic Display
C	Soft Keys	K	Mean Display
D	Print Key	L	Graphic LCD Display
E	Paper Feed Key	M	Battery Operation Indicator (Orange)
F	Increment Key	N	Battery Low Indicator (Red)
G	Decrement Key	O	AC Power Indicator (Green)
H	Mute Key	P	Alarm Mute Indicator (Red)

CONTROLS, INDICATORS AND SYMBOLS

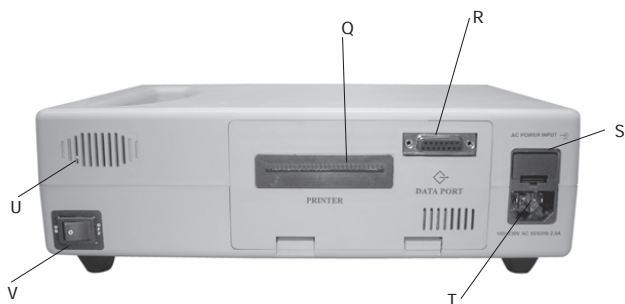

Figure 2 : Model 960 Series Rear Panel

- Q Printer
- R Data Port Connector (OPTIONAL)
- S AC Fuse Holder
- T AC Power Inlet
- U Speaker
- V ON / OFF Switch

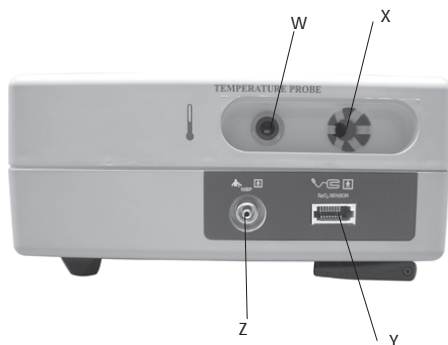



















Figure 3 : Model 960 Series Left Side Panel

- W Temperature Sensor Port
- X Temperature Sensor Holder
- Y SpO₂ Sensor Port
- Z NIBP Port

CONTROLS, INDICATORS AND SYMBOLS

3.2 SYMBOLOGY & MARKINGS

<u>Symbol</u>	<u>Definition</u>
%SpO ₂	Oxygen Saturation Percentage
BPM	Heart Beats per Minute (BPM)
	Power On / Off
	Start / Stop Key
	Print Key
	Paper Feed Key
	Alarm Mute
	Increment Key
	Decrement Key
	AC Power Indicator
	Battery / Low Battery Indicator
	Data Port
	Sensor Cable Connection
	Temperature Sensor Connection
	NIBP Cable Connection
	AC Power Connection
	Attention: Consult Accompanying Documents
	Non-anesthetic Proof
	Type BF Applied Part
	Type BF Applied Part (Defib Proof)

CONTROLS, INDICATORS AND SYMBOLS

3.3 DESCRIPTION OF CONTROLS, DISPLAYS, INDICATORS & CONNECTORS

FRONT PANEL

A. POWER ON/OFF KEY



The unit is powered on with a short depression of the POWER ON/OFF KEY. A long beep sound followed by a three (3)-seconds display, indicator test and self-test is performed automatically. All visual indicators, AC power indicator (if the unit is on AC mains power) and the LCD backlight, are illuminated. All the segments of the Systolic, Diastolic and Mean LED's are illuminated. A non-functioning segment will result in an incomplete numeral and possible erroneous reading.

B. START/STOP KEY



This key is used to start/stop the NIBP measurement.

C. SOFT FUNCTION KEYS

The four SOFT FUNCTION KEYS have multiple uses depending on the legend displayed in the LCD screen above the key.

D. PRINT KEY



The PRINT KEY is used for printing patient data.

E. PAPER FEED KEY



The PAPER FEED KEY is used for advancing the paper out of the monitor.

F-G. INCREMENT & DECREMENT KEYS



The pulse tone volumes can be adjusted using the INCREMENT / UP and DECREMENT / DOWN KEYS. There are five (5) levels of audible (pulse) tone volume.

H. ALARM MUTE KEY



The ALARM MUTE KEY will be operational only when any monitor alarm is activated. A short depression of this key silences the alarm for a period to 30, 60, 90,120 seconds as set by the user. The ALARM MUTE indicator in the LCD screen (a crossed speaker symbol) will be displayed and the ALARM MUTE indicator LED will glow. Silenced alarms can be reactivated by a short depression of the ALARM MUTE KEY.

Also the Silenced & Disabled alarms will be reactivated as soon as a fresh alarm condition is generated.

CONTROLS, INDICATORS AND SYMBOLS

I. SYSTOLIC DISPLAY

The seven segment Red LED's display the Systolic value. A blinking display indicates that the value has violated the alarm limits.

J. DIASTOLIC DISPLAY

The seven segment Green LED's display the Diastolic value. A blinking display indicates that the value has violated the alarm limits.

K. MEAN DISPLAY

The seven segment Orange LED's display the Mean value. A blinking display indicates that the value has violated the alarm limits.

L. GRAPHIC LCD DISPLAY

The GRAPHIC LCD DISPLAY has multiple uses depending on the current mode. In the normal operation whenever the monitor receives at least three (3) valid pulses during a 15-second period, the plethysmographic waveform is displayed. It also displays the values of SpO₂, BPM and Temperature, Visual Alarms, Error / Status Messages, Beep volume level, Alarm Mute status, Battery-charge status and Menu.

It also displays the upper and lower alarm limits of %SpO₂, Pulse-Rate, Systolic and Diastolic parameters.

%SpO₂ Value:

%SpO₂ value is displayed in the upper right corner of the LCD. The value is updated with every normal pulse. A blinking display signals that %SpO₂ monitoring may be adversely affected and also indicates that the %SpO₂ value has violated the alarm limits.

PULSE RATE Value:

Pulse Rate value is displayed in the lower right corner of the LCD. The value is updated with every normal pulse. A blinking display signals that Pulse Rate monitoring may be adversely affected and also indicates that the BPM value has violated the alarm limits.

TEMPERATURE Value:

Temperature value is also displayed on the LCD. It can be viewed in both Fahrenheit and Centigrade scale. A blinking display signals that Temperature monitoring may be adversely affected and also indicates that the temperature value has violated the alarm limits.

M. BATTERY OPERATION INDICATOR



The orange LED for Battery Operation Indication will illuminate when the monitor is being operated on battery.

CONTROLS, INDICATORS AND SYMBOLS

N. BATTERY LOW INDICATOR

The red LED for Battery Low Indication will illuminate when the battery is near depletion, prompting the user to recharge/change the battery immediately. The MONITOR will power off shortly after Battery Low Indication.

O. AC POWER INDICATOR



The green LED for AC Power Indication, located above the battery indicators will illuminate when the MONITOR is connected to AC power. In this mode the battery undergoes charging.

P. ALARM MUTE INDICATOR

The ALARM MUTE INDICATOR will illuminate and remain on constantly when audible alarms are silenced.

REAR PANEL

R. DATA PORT



The DATA PORT is used for serial communication, analog output and for Nurse Call feature. To eliminate risk of shock, take care not to touch the DATA PORT 15-pin Connector and the patient simultaneously. The DATA PORT should be used only for connection to equipment that complies with CSA/IEC/UL601-1.

T. AC POWER INLET



For electric power, plug the AC power cord into the AC POWER INLET on the rear panel on the monitor and then plug the other end of cord into a standard electrical outlet.

V. ON/OFF SWITCH

The ON/OFF SWITCH is located at the back of the oximeter. When this Switch is turned Off the oximeter gets totally isolated from DC power. When this Switch is turned On, the oximeter gets powered from AC Mains, when it is connected to AC Mains, else it gets powered by battery.

LEFT PANEL

W. TEMPERATURE SENSOR CONNECTION



The temperature connector on the monitor is used to connect to the temperature probe. Insert the temperature probe in the temperature connector on the monitor till it locks in properly.

Y. SpO₂ SENSOR CABLE CONNECTION



All Mediaid Pulse Oximeter sensors with Compushield connectors are compatible with the Model 960 Series. To connect a sensor to the monitor, align the sensor plug with the jack on the monitor's sensor port and insert gently until an audible "click" is heard. To remove, squeeze the locking tab on the plug and slide the plug out of the jack. Always route cords in such a way so as to prevent accidental tripping and subsequent damage to the monitor.

CONTROLS, INDICATORS AND SYMBOLS

Z. NIBP CUFF CONNECTION



The NIBP connector on the monitor is used to connect to the cuff hose. Attach the cuff hose to the NIBP connector and rotate it clockwise till it tightens. Do not over tighten it.

3.4 ALARM LEVELS

The Model 960 Series has 3 levels of Audio Alarms

A. High-Priority Alarm:

Indicated by a fast-rate pulsing tone. A High-Priority Alarm sounds when the monitor does not detect a pulse or when the high or low patient parameter limits are breached.

B. Medium-Priority Alarm:

Indicated by a medium-rate pulsing tone. A Medium-Priority Alarm sounds when the battery is near depletion or when there is a "No Finger" condition and temperature high and low condition.

C. Low-Priority Alarm:

Indicated by a slow-rate pulsing tone. A Low-Priority Alarm sounds when there is "No Sensor" condition or when the temperature limits are breached.

3.5 DESCRIPTION OF AUDIBLE ALARMS

No Pulse

When the monitor does not detect a valid pulse after searching for approximately 30 seconds, a High-Priority alarm sounds and a "NO PULSE" message is displayed on the graphical LCD display.

High or Low Oxygen Saturation

When the high or low Oxygen Saturation alarm limits are breached, a High-Priority alarm sounds along with a blinking SpO₂ value and a "HIGH SAT" or "LOW SAT" message is displayed on the graphical LCD display.

High or Low Pulse Rate

When the high or low Pulse Rate alarm limits are breached, a High-Priority alarm sounds along with a blinking BPM value and a "BPM HIGH" or "BPM LOW" message is displayed on the graphical LCD display.

High or Low Systolic Rate

When the high or low Systolic alarm limits are breached, a High-Priority alarm sounds along with a blinking Systolic value and a "HIGH SYST" or "LOW SYST" message is displayed on the graphical LCD display.

CONTROLS, INDICATORS AND SYMBOLS

High or Low Diastolic Rate

When the high or low Diastolic alarm limits are breached, a High-Priority alarm sounds along with a blinking Diastolic value and a "HIGH DIA" or "LOW DIA" message is displayed on the graphical LCD display.

High or Low Mean Rate

When the high or low Mean alarm limits are breached, a High-Priority alarm sounds along with a blinking Mean value and a "HIGH MEAN" or "LOW MEAN" message is displayed on the graphical LCD display.

High or Low Temperature Levels

When the high or low Temperature alarm limits are breached, a Medium-Priority alarm sounds along with a blinking Temperature value and a "HIGH TEMP" or "LOW TEMP" message is displayed on the graphical LCD display.

Low Battery

When the Battery is near depletion, a Medium-Priority alarm sounds and the low battery indicator glows prompting the user to recharge/change the battery. A "LOW BATTERY" message also flashes every one minute on the graphical LCD display.

No Finger in Sensor

When there is no finger in the sensor, a Medium-Priority alarm sounds and a blinking "NO FINGER" message is displayed on the graphical LCD display.

No Sensor / Disconnected Sensor

When the sensor is not connected to the monitor, a Low-Priority alarm sounds and a blinking "NO SENSOR" message is displayed on the graphical LCD display.

Chapter 4:

SET UP

Unpacking and Inspection

List of Components

Monitor Setup

4.1 UNPACKING AND INSPECTION

Notify the carrier if the shipping carton is damaged. Unpack the Model 960 Series and components. If anything is missing as per the List of Components or damaged, contact Mediaid Inc. or the Mediaid local authorized distributor.

4.2 LIST OF COMPONENTS

1. Model 960 Series monitor
2. Mediaid Reusable sensor
3. NIBP cuff
4. Temperature probe
5. Printer paper (already installed)
6. AC Power Cord
7. Model 960 Series User's Manual
8. Additional Accessories as ordered, if any

4.3 MONITOR SETUP

General Warnings

WARNING: To ensure patient safety, do not place the monitor in any position that might cause it to fall on the patient.

WARNING: As with all medical equipment, carefully route patient cabling to reduce the possibility of patient entanglement or strangulation.

WARNING: Disconnect the Model 960 Series and Mediaid sensor from the patient during magnetic resonance imaging (MRI) scanning. Induced current could potentially cause burns. The Model 960 Series may affect the MRI image and the MRI unit may affect the accuracy of monitor measurements.

WARNING: To ensure accurate performance and prevent device failure, do not subject the Model 960 Series to extreme moisture, such as direct exposure to rain. Such exposure may cause inaccurate performance or device failure.

SET UP

WARNING: Do not use a Model 960 Series monitor, AC Power cord, sensor, sensor cable or connector, NIBP Cuff , temperature sensor, that appear to be damaged.

WARNING: The Model 960 Series is not defibrillator-proof. However, it may remain attached to the patient or while an electro surgical unit is in use, but the readings may be inaccurate during use and shortly thereafter.

WARNING: When Model 960 Series monitor is used along with other patient connected medical electronic equipment, care should be taken to ensure that the other medical electronic equipment and its sensor cables are safe to use. Please refer to the manufacturer's document for more information. Failing to comply with this may result in electrical hazard, burns to the patient.

Connecting the Model 960 Series to AC Power

The power inlet is located at the rear of the monitor. Insert one end of the power cord to the power inlet and the other end to the AC mains supply. The AC Power Indicator will illuminate. In this mode the battery undergoes charging.

Power On

- Place the Model 960 Series on a flat surface near the patient.
- Attach the line cord to the Model 960 Series and to the AC outlet, respectively.
- Plug the unit into a hospital grade receptacle. If battery operation is required, ensure that a fully charged battery is installed.
- Switch on the ON/OFF SWITCH located at the rear side of the oximeter.
- Verify that the AC POWER INDICATOR is lit. If it is not, ensure that the ON/OFF SWITCH is in the "ON" position. If the indicator still does not light, check the local AC power at the wall outlet. If the problem still persists, contact Medaid Inc. or the Medaid local authorized distributor/service center.
- Switch on the POWER ON/OFF KEY located at the front of the monitor. Internal self tests will run and the unit enters the monitoring mode.

Chapter 5:

DETAILED OPERATING INSTRUCTIONS

General Precautions
SpO₂ Measurements
Selecting a Sensor
Biocompatibility Testing
Performance Considerations
NIBP Measurements
Start and Stop Functions
Temperature Measurements
Printer (Optional)
Functional Test Mode (Diagnostic Mode)
Adjustable Settings
Menu
Limits
Setup
Pleth / Blip View
Trend
NIBP Cycle Time
Nurse Call (Optional Feature)
Analog (Optional Feature)
Default Settings
Battery Operation
Disposal of Device Components
Performance Considerations

5.1 GENERAL PRECAUTIONS

WARNING: The Model 960 Series is prescription device and is to be operated by qualified personnel only.

WARNING: Do not lift the monitor by the sensor cable or power cord because the cable could disconnect from the monitor, causing the Monitor to drop on the patient.

WARNING: The Model 960 Series is intended only as an adjunct in patient assessment. It must be used in conjunction with clinical signs and symptoms.

WARNING: Monitor readings can be affected by certain ambient environmental conditions, sensor application errors, and certain patient conditions. See the appropriate sections of the manual for specific safety information.

WARNING: Do not silence the audible alarm or decrease its volume if the patient safety could be compromised.

DETAILED OPERATING INSTRUCTIONS

WARNING: Each time the monitor is used, check alarm limits to ensure that they are appropriate for the patient being monitored.

Important ! Prior to using the Model 960 Series, carefully read this manual, accessory directions for use, all precautionary information in boldface type, and all specifications.

Before using the Model 960 Series in a clinical setting, verify that the monitor is working properly and is safe to use. Proper working condition can be verified by successful completion of the power-on self-test, and by following instructions contained in the "Monitoring Mode" paragraph of this section.

5.2 SpO₂ MEASUREMENTS

1. Gently Insert the Medaid SpO₂ cable into the sensor connector located on the left panel of the monitor until a "click" is heard.
2. Apply the sensor end of the cable to the patient.
3. A "SEARCHING" message is displayed on the graphic LCD display, while the monitor searches for a valid pulse.
4. When a valid pulse is detected, the SpO₂ and the BPM values are displayed on the LCD.

5.3 SELECTING A SENSOR

WARNING: Before use, carefully read the sensor directions for use, including all warnings, cautions and instructions.

WARNING: Use only Medaid sensors and sensor cables with this monitor. Other sensors or sensor cables may cause improper Model 960 Series performance.

WARNING: Do not use a damaged sensor or sensor cable. Do not use a sensor with exposed optical components.

WARNING: Do not attach any cable intended for other use, to the Model 960 Series sensor port. This may damage the communication port.

WARNING: Tissue damage can be caused by incorrect applications or duration of use of a SpO₂ sensor. Inspect the sensor site periodically as directed in the sensor directions for use.

DETAILED OPERATING INSTRUCTIONS

When selecting a sensor, consider the patient's weight and activity level, the adequacy or perfusion, the available sensor sites, the need for sterility, and the anticipated duration of monitoring. For more information, refer to Table 1 or contact Mediad Inc. or the Mediad local authorized distributor.

WARNING: Follow the Cleaning Instructions of sensors as mentioned in the Mediad sensor Instruction Sheet. The Mediad sensor can be cleaned by wiping it off with a soap or glutaraldehyde solution. CAUTION: Do not steam autoclave or immerse in water or other solutions.

Table 1: Mediad Sensors

S.No.	Sensor	Part Number
1	Universal Hinged Sensor, Compushield connector, 30" cable	POX050-100S
2	Universal Hinged Sensor, Compushield connector, 96" cable	POX050-105S
3	Spot Check Soft Sensor, Compushield connector, 30" cable	POX050-150S
4	Great Toe Sensor, Compushield connector, 96" cable	POX050-220S
5	Small Soft Sensor, Compushield connector, 96" cable	POX050-300S
6	Large Soft Sensor, Compushield connector, 96" cable	POX050-400S
7	Pediatric Soft Sensor, Compushield connector, 96" cable	POX050-310S
8	Earlobe Clip Sensor, Compushield connector, 96" cable	POX050-710S
9	Pediatric Adjustable Sensor, Compushield connector, 96" cable	POS050-530S
10	Tape-on Sensor, Compushield connector, 96" cable	POX050-850S
11	Adult R-Adhesive Sensor, Compushield connector, 96" cable	POX050-905S
12	Pediatric R-Adhesive Sensor, Compushield connector, 96" cable	POX050-820S
13	6 Feet Extension Cable, Compushield to Compushield connector	POX055-600S
14	6 Feet Adapter Cable, Compushield to RJ12 connector	POX055-610S
15	Adult Adhesive Disposable Sensor, RJ12 connector	POX020-950
16	Pediatric Adhesive Disposable Sensor, RJ12 connector	POX020-960

5.4 BIOCOMPATIBILITY TESTING

Biocompatibility testing has been conducted on Mediad sensors in compliance with ISO 10993-1, Biological Evaluation of Medical Devices, Part 1: Evaluation and Testing. The sensors have passed the recommended biocompatibility testing and are therefore in compliance with ISO 10993-1.

5.5 PERFORMANCE CONSIDERATIONS

WARNING: Monitor readings and pulse signal can be affected by certain ambient environmental conditions, sensor application errors and certain patient conditions.

DETAILED OPERATING INSTRUCTIONS

Inaccurate measurements can be caused by:

- Incorrect application of the sensor.
- Placement of the sensor on an extremity with a blood pressure cuff, arterial catheter, or intravascular line.
- Ambient light.
- Prolonged patient movement.

Loss of pulse signal can occur for the following reasons:

- The sensor is too tight.
- A blood pressure cuff is inflated on the same extremity as the one with the sensor attached.
- There is an arterial occlusion proximal to the sensor.

Use only Mediad sensors and sensor cables

Select an appropriate sensor, apply it as directed, and observe all warnings and cautions presented in the directions of use accompanying the sensor. Clean and remove any substances such as nail polish from the application site. Periodically check to ensure that the sensor remains properly positioned on the patient.

WARNING: Tissue damage can be caused by incorrect application or duration of use of a SpO₂ sensor. Inspect the sensor site as directed in the sensor directions for use.

High ambient light sources such as surgical lights (especially those with a xenon light source), bilirubin lamps, fluorescent lights, infrared heating lamps and direct sunlight can interfere with the performance of the SpO₂ sensor. To prevent interference from ambient light, ensure that the sensor is properly applied, and cover the sensor site with an opaque material.

NOTE: Failure to take this precaution in high ambient light conditions may result in inaccurate measurements.

If patient movement presents a problem, try one or more of the following remedies to correct the problem.

- Verify that the sensor is properly and securely applied.
- Move the sensor to a less active site.
- Use an adhesive sensor that tolerates some patient movement.
- Use a new sensor with fresh adhesive backing.

NOTE: The preceding section pertains to the patient and environmental conditions that can be addressed by sensor selection and application. For information regarding the impact of other patient environmental conditions on monitor performance, see "Performance Considerations" in the Start Up and Use section of this manual.

DETAILED OPERATING INSTRUCTIONS

5.6 NIBP MEASUREMENTS

Manual NIBP Mode

1. Select a pressure cuff that is appropriate for the size of the patient.

NOTE: A cuff that is too narrow for the limb will result in erroneously high readings. The correct size of the pressure cuff for a given patient has, among other considerations, a direct bearing on the accuracy of the obtained NIBP measurements. Base your selection of the cuff size on the limb circumference of the patient. The design dimensions of the cuffs and their intended uses are based on recommendations of the American Heart Association.

NOTE: Cuffs become brittle as they age and sometimes develop permanent folds that can leave temporary marks on the limb. Any cuffs that exhibit this effect should be replaced.

NOTE: Ensure that the pressure tubes are not compressed or restricted.

WARNING: Do not squeeze the rubber tube on the cuff. Do not allow liquid to enter the connector socket of the monitor. Do not wipe the inner part of the connector socket when cleaning the monitor.

NOTE: The pressure on the limb may not fall to zero between measurements if the cuff is wrapped too tightly. Therefore, ensure that the cuff is properly applied.

NOTE: The skin is sometimes fragile (i.e., on pediatrics, geriatrics, etc.). In these cases, a longer time interval between measurements should be considered to decrease the number of cuff inflations over a period of time. In extreme cases, a thin layer of soft roll or webril cotton padding may be applied to the limb in order to cushion the skin when the cuff is inflated. This measure may affect NIBP performance and should be used with caution.

WARNING: Do not perform NIBP measurement on a patient of sickle-cell disease or with damaged skin or expected damaged skin.

2. Attach cuff hose to NIBP connector.
3. Align the NIBP hose connector to the connector, which is provided on the left of the sensor panel and then rotate it once so that it is firmly fixed.
4. Apply the cuff to the patient. To reduce errors, the cuff should be fitted snugly, with little or no air present within the cuff. Be sure the cuff lies directly against the patient's skin. No clothing should come between the patient and the cuff.

NOTE: The NIBP cuff should not be placed on a limb that is being utilized for any other medical procedure. For example an IV catheter or an SpO₂ sensor.

5. If not already selected, select the Patient Type as described in Menu section. Choices are Adult or Neonate.
6. If necessary, change the initial inflation, by pressing the key **CYCLE** on the main menu, followed by **SLCT** to select the "INITIAL INFLATE" option and then use **▲** or **▼** to change the initial inflate pressure.

DETAILED OPERATING INSTRUCTIONS

Patient Size Setting	Initial Cuff Inflation Values	Default Setting	Maximum Inflation Values
Adult	120 – 280 mmHg	160 mmHg	300 mmHg
Neonate	60 – 140 mmHg	90 mmHg	150 mmHg

7. Press START to begin a NIBP measurement.

NOTE: "Manual" is displayed on the Graphic LCD display indicating that the unit is in the Manual NIBP mode.

NOTE: Inflate the cuff only after proper application to the patient's limb. Cuff damage can result if the cuff is left unwrapped and then inflated.

The cuff begins to inflate to the selected cuff pressure. After reaching the selected value the cuff begins to slowly deflate and the Model 960 Series collects oscillometric pulsations.

If the initial cuff inflation is found to be inadequate, the unit retries with a higher inflation pressure (+50 mmHg in the adult mode, +40 mmHg in the neonate mode).



Have the patient remain still to avoid the introduction of unnecessary motion artifact. After the cuff pressure falls below the diastolic pressure, the results of the measurement are displayed.

If NIBP is the only parameter, being measured with the Model 960 Series, a heart rate can be derived from NIBP. If another heart rate source is available, the NIBP heart rate will be replaced by the heart rate from the selected source.

8. If desired, press STOP to interrupt a measurement. The cuff will deflate.

Automatic NIBP Mode

In this mode time intervals can be set to automatically take the NIBP measurements. For example, if the interval is set to 5 minutes, NIBP measurements are taken every 5 minutes.

- Follow the steps 1- 5 in the Manual NIBP Mode.
- Press the **CYCLE** key in the main menu followed by **SLCT** until the "Cycle Time" option is selected and then use  or  to change the cycle time. The choices are OFF, 1, 3, 5, 10, 15, 30, 60, 90 minutes.
- The unit will automatically start taking measurements at the set intervals. The timer can be seen on the graphic LCD display indicating that the unit is in the AUTO NIBP mode.

WARNING: Prolonged NIBP measurements in Auto mode may be associated with ischemia and neuropathy in the limb wearing the cuff. When monitoring a patient, examine the extremities of the limb frequently for normal color, warmth and sensitivity. If any abnormality is observed, stop the blood pressure measurements.

NOTE: The unit will always remain in the Auto mode unless it's changed to the manual mode.

DETAILED OPERATING INSTRUCTIONS

Adjustment of the Inflation Pressure

After the first BP reading has been performed, the next initial inflation pressure will be at 30mmHg above the previous Systolic reading.

Suspension of NIBP Measurement

1. Press STOP to end a measurement cycle already in progress (deflate cuff).
2. Press START to take an immediate measurement.

NOTE: Press STOP at any time to terminate a measurement cycle already in progress.

NIBP Pressure limit Fail Safety

The safety circuitry oversees normal operation and will override to abort a reading if:

- Cuff pressure exceeds 300 mmHg (adult mode) or 150 mmHg (neonate mode) at any time.
- The cuff has been inflated for 180 seconds (adult mode) or 90 seconds(neonate mode).

Cuff Inflation Time

The operating software ensures that:

- Maximum cuff inflation time is limited to 50 seconds.
- Duration of blood pressure reading is limited to 130 seconds(adult mode) and 75 seconds(neonate mode).

5.7 START AND STOP FUNCTIONS

The START and STOP functions have the following effects on the timed measurement sequence.

- **INTERVAL is set and press START:**

An unscheduled measurement is made. Taking this unscheduled measurement does not affect the timing of the interval cycle; therefore, the scheduled measurements will be taken as if there were no interruptions. Only one measurement is taken for each measurement cycle – therefore, if the unscheduled measurement coincides with the scheduled measurement, it counts as the scheduled measurement.

- **INTERVAL is set and press STOP during the measurement:**

The cuff deflates and interval measurements for that interval is suspended.

- **INTERVAL is set and change the interval:**

The measurement cycle is reset with the new interval.

DETAILED OPERATING INSTRUCTIONS

5.8 TEMPERATURE MEASUREMENTS

The Temperature measurement function of the Model 960 Series is designed to take a single temperature reading from YSI 400 or compatible probes. Insert the temperature probe into the connector on the left panel of the monitor. The temperature scale can be changed between Fahrenheit to Centigrade.

To change the temperature scales between Fahrenheit and Centigrade:

Press **SETUP** followed by **NEXT** and then **TEMP** .

The temperature display on the LCD will change between C and F.

WARNING: Temperature probe can be cleaned by wiping it off with glutaraldehyde solution/ 70% Isopropyl alcohol solution.

5.9 PRINTER (OPTIONAL)

Setting up a Customized Name on the Printout:

A customized name, eg. a hospital name, can be setup initially so that any printout will have that name printed on it.

To set up a hospital name:

- Turn on the unit by **pressing** .
- As soon as the Mediaid logo is displayed Press and for about 3 seconds.
- The following message appears "Enter the Hospital Name".
- Press or keys to scroll alphabets and numbers.
- Press **FWRD** to move the cursor forward.
- Press **DEL** to delete the entire data.
- Press **RVSE** to move the cursor backwards.
- Press **STORE** to store the data.
- Turn the unit off.

NOTE: The printer will print only when there is valid measured data displayed on monitor. If there is no valid measured data displayed and the PRINT key is pressed, a "NO DATA AVAILABLE" message is flashed on the LCD display.

DETAILED OPERATING INSTRUCTIONS

NOTE: The Printer will not print during a NIBP measurement. If the **PRINT** key is pressed during a NIBP measurement a message, "WAITING FOR NIBP DATA" is displayed on the LCD. The data will be printed only when the NIBP measurement is done and valid data is displayed on the monitor.

NOTE: The printer is automatically disabled during a Low Battery condition.

Manual Mode Printing

- Press **PRINT** at any time to print the measured data displayed on the monitor. If no valid data is displayed and the **PRINT** key is pressed, a "NO DATA AVAILABLE" message is flashed on the LCD display.

The format of the manual printout is shown below:

MEDI AID	
DATE	: 21 MAR 06 13 : 17
PATIENT ID	:
PATIENT NAME	:
%SpO ₂	: 90
BPM	: 75
SYSTOLIC	: 122 mmHg
DIASTOLIC	: 85 mmHg
MEAN	: 97 mmHg
TEMPERATURE	: 25.7 C

Automatic Mode Printing

In this mode a timer can be set to print the data every 1, 2, 3, 5, 10, 15 and 30 minutes.

- Press **SETUP** followed by **NEXT**.
- Press **SLCT** until the "PRINT MODE" option is highlighted.
- Use **▲** or **▼** to select the time interval.

NOTE: A star "*" printed next to the any row on the printout during an Auto Mode Printing, indicates that one of the parameters has violated the alarm limits.

DETAILED OPERATING INSTRUCTIONS

The format of the automatic mode printout is shown below:

MEDIAID						
PATIENT ID	:					
PATIENT NAME	:					
LIMITS	:	HIG			LOW	
%SpO ₂	:	100			96	
BPM	:	170			40	
SYSTOLIC	:	200			70	
DIASTOLIC	:	160			50	
MEAN	:	180			60	
TEMPERATURE	:	98.6F			84.2F	
DATE : 21 MAR 06						
.....						
TIME	%O2	BPM	SYS	DIA	MEA	TEMP-F
.....						
* 14:52	92	75	125	86	99	99.1
14:53	97	77	125	86	99	99.2

Paper Feed Key

The paper feed key is used to advance the printer paper.

To advance the printer paper:

- Press 

Loading the Printer Paper

Follow the instructions below to load the printer paper:

- Remove the Rear panel door from the Model 960 Series.
- Carefully pull the printer tray till the opening is just enough to put one paper roll. See fig.4.



Figure 4 : Printer tray open

Caution: Do not pull the printer tray out completely since it may snap the printerconnection inside the monitor.

DETAILED OPERATING INSTRUCTIONS

- Observe the direction in which the Platten is snapped to the printer head. See fig.5.



Figure 5: Platten direction

- Carefully remove the Platten as shown in the fig. 6.



Figure 6: Platten removed

- Insert new paper roll in the tray such that the shiny side of the paper faces the printer head when we unroll the paper.
- Unroll approximately 4 inches of paper.
- Align the paper across the top rounded edge of the printer tray.
- Carefully snap the platten on the printer head such that the paper alignment does not change. See fig. 7.





Figure 7: Platten fixing

- Carefully push the printer tray inside the enclosure.
- Take the loose edge of the paper through the printer paper opening on the back panel.
- Carefully snap the back panel to the Model 960 Series

DETAILED OPERATING INSTRUCTIONS





5.10 FUNCTIONAL TEST MODE (DIAGNOSTIC MODE)

To get into the Functional-test mode:

- Turn on the unit by **pressing** .
- As soon as the Mediaid logo appears **press**  and  simultaneously for about 3 seconds.
- The unit enters the Functional test mode and the following needs to be observed:
 - i. All the segments of the 7-segment LED display for Systolic, Diastolic and Mean should be glowing.
 - ii. All the visual indicators (Mute, Battery, Low battery and AC power LED's) should be glowing.

LED Functional Test

In the Functional Test Mode:

- **Press**  followed by  to select the required field.
- **Use**  or  to check for the LED segments and indicators.

LCD Functional Test

In the Functional Test Mode:

- **Press** . The unit will automatically start the LCD test. Check for any damaged pixels.





KEY Test

In the Functional Test Mode:

- **Press** any  and check for the response.

Speaker Test

In the Functional Test Mode:

- **Press**  followed by  and then **press**  to select "SPEAKER TONE".
- **Use**  or  to vary the frequency between 600 Hz and 5 KHz.

DETAILED OPERATING INSTRUCTIONS

Analog Channel and Nurse Call Test

In the Functional Test Mode:

- Press **NEXT** followed by **COMM** and then **press SLCT** to select "ANALOG CH0 to ANALOG CH6" or the "NURSE CALL" option

If any Analog Channel is selected:

- Press **▲** or **▼** to vary the voltage between 0.1V to 1V and check for the corresponding voltage on the respective 15 pin connector on the rear panel of the monitor, with respect to ground (pin 5)

Description	Analog CH0	Analog CH1	Analog CH2	Analog CH3	Analog CH4	Analog CH5	Analog CH6	GROUND
Pin No on the DB15 (Dataport connector)	1	10	11	4	12	13	14	5 and 15

If Nurse Call is selected:

- Press **▲** or **▼** to turn the relay inside the monitor ON and OFF. The relay makes a click sound every time it turns ON or OFF.

RS232 Test



In the Functional Test Mode:

- Press **NEXT** followed by **COMM** and then **press RS232**. The following message appears. "PLEASE INSERT RS232 PLUG AND PRESS TEST KEY".
- Insert the RS232 plug into the DB15 connector behind the monitor.
- Press **TEST**. The test passes if "PASS" is displayed on the LCD or fails if "FAIL" is displayed on the LCD.

DETAILED OPERATING INSTRUCTIONS

Printer Test

In the Functional Test Mode:



- Press **NEXT**  followed by **PRINT** . The status of Printer Paper, Platen Switch and the Thermal Head Temperature is displayed on the LCD.
If paper is present then a sample printout is also printed.

Caution: If any failure noticed in the above Diagnostic-test procedure, do not use the monitor. Instead contact Mediaid Inc. or the local authorized distributorservice center.

5.11 ADJUSTABLE SETTINGS

Pulse Beep Volume





To adjust the pulse beep volume during normal monitoring:

- Press  or  to change the beep volume level. There are five (5) levels of audible (pulse) tone volume.

Setting Pulse Beep Frequency

The Pulse Beep Frequency can be adjusted between 250 Hz to 3 KHz. The factory default setting is 550Hz.





To set the Pulse Beep Frequency:

- Turn on the unit by **pressing** .
- As soon as the Mediaid logo is displayed press the first two soft function keys (see fig 1, keys "C") for about 3 seconds.
- The following message appears "BEEP FREQ FOR 100% SPO2".
- Press  or  to change the frequency.
- Press **STORE**  to store the value.
- Turn the unit off.

Alarm Mute

The ALARM MUTE KEY will be operational only when any monitor alarm is activated. A short depression of this key silences the alarm for a period of 30, 60, 90 or 120 seconds depending on the selection.

DETAILED OPERATING INSTRUCTIONS

- **Press**  and hold for 3 seconds. While holding **press**  or  to change the time interval to 30, 60, 90 or 120 seconds.
- **Press**  again to mute the alarm to the above set time.

The ALARM MUTE indicator on the LCD screen (a crossed speaker symbol) will be displayed and the ALARM MUTE indicator LED will glow. Silenced alarms can be reactivated by a short depression of the ALARM MUTE KEY.

The Silenced alarms will be reactivated as soon as a fresh alarm condition is generated. Visual indications of an alarm conditions cannot be turned off. For example, if the %SpO₂ upper alarm limit is breached, the audio alarm can be silenced for the alarm silence duration, but the %SpO₂ value on the LCD display and the "HIGH-SAT" message will continue to blink indicating the Alarm condition.

WARNING: Do not compromise on patient safety by silencing the audible alarms.

DETAILED OPERATING INSTRUCTIONS

5.12 MENU

To select a menu field, press and release the corresponding soft keys directly below the field.

NOTE: If, after accessing a submenu, no keys are pressed for approximately 15 seconds, the display will time out and return to the main.

A description of each menu item is included in the following paragraphs.

Figure 8: Menu Structure

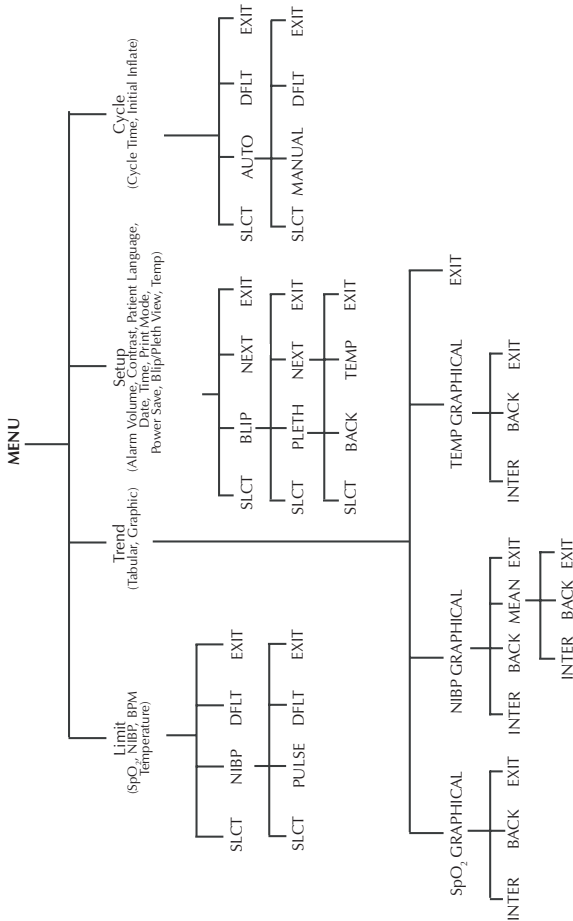

DETAILED OPERATING INSTRUCTIONS

5.13 LIMITS

WARNING: Each time the monitor is used, check alarm limits to ensure that they are appropriate for the patient being monitored.

Overview

When the Model 960 Series is first turned on, alarm limits are set to their power-on factory default values.

Alarm limits may be changed from their power-on factory default values if necessary, as described below. Limit changes made will remain in effect until changed again.

Viewing Current Alarm Limits

The current upper and lower alarm limits for %SpO₂, BPM, Systolic, Diastolic rate are constantly displayed on the Graphic LCD display.

From the main menu:

- Press **LIMIT** to view upper and lower limits of %SpO₂, BPM, TEMP. Refer to Fig.9.
- Press **LIMIT** followed by **NIBP** to view upper and lower limits of Systolic, Diastolic and Mean. Refer to Fig.10.

Changing Alarm Limits

(i) %SpO₂, BPM, TEMP Alarm Limits

From the main menu:

- Press **LIMIT** followed by **SLCT** to the select desired parameter.
- Use or to change the limits.

The limit value settings take effect immediately and remain in effect when that alarm-setting menu is exited.

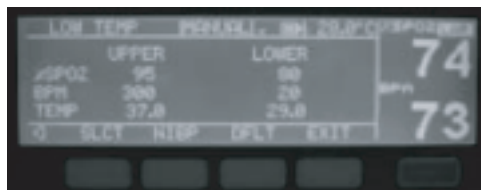

Figure 9: SpO₂, BPM and Temperature Alarm Limits Setting

DETAILED OPERATING INSTRUCTIONS

For Default Limits setting from the main menu:

- Press **LIMIT** followed by **DFLT** .

(ii) **SYSTOLIC, DIASTOLIC, MEAN Alarm Limits**

From the main menu:

- Press **LIMIT** followed by **NIBP** and then **SLCT** to select desired parameter.
- Use or to change the limits.

The limit value settings take effect immediately and remain in effect when that alarm-setting menu is exited.

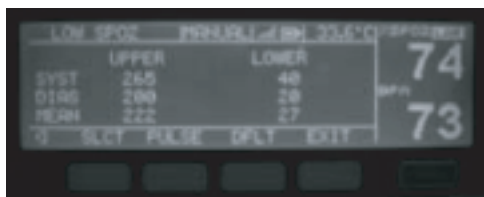

Figure 10: NIBP Alarm Limits Setting

For Default Limits setting from the main menu:

- Press **LIMIT** followed by **NIBP** and then **press** **DFLT** .

NOTE: The default limits will be different depending on the patient type.

Adult Default Limits:

	DEFAULT UPPER LIMIT	DEFAULT LOWER LIMIT
%SpO ₂	100	85
BPM	170	40
TEMP	37.0 °C (98.6 °F)	29.0 °C (84.2 °F)
SYSTOLIC	200	70
DIASTOLIC	160	50
MEAN	180	60

DETAILED OPERATING INSTRUCTIONS

Neonate Default Limits:

	DEFAULT UPPER LIMIT	DEFAULT LOWER LIMIT
%SpO ₂	95	80
BPM	190	90
TEMP	37.0 °C (98.6 °F)	29.0 °C (84.2 °F)
SYSTOLIC	110	60
DIALOSTIC	70	30
MEAN	90	40

NOTE: The SpO₂ and BPM alarm limits can be varied between their measurement ranges as mentioned in the specification. The minimum difference between the lower and upper limit is 2. The Temperature alarm limits can be varied between their measurement ranges as mentioned in the specification. The minimum difference between the lower and upper limit is 0.2. In the Adult mode the NIBP limits can be varied as given below:

Systolic: 40mmHg-260mmHg; Diastolic: 20mmHg-200mmHg; Mean: 20mmHg-230mmHg. The minimum difference between the lower and upper limit is 2.

In the Neonate mode the NIBP limits can be varied as given below:

Systolic: 20mmHg-130mmHg; Diastolic: 20mmHg-120mmHg; Mean: 25mmHg-115mmHg. The minimum difference between the lower and upper limit is 2.

NOTE: Peak wavelength of SpO₂ sensor: Red LED - 660 ± 2nm@60 µW, IR LED - 910 ± 10nm@150 µW.

SpO₂ waveforms are normalized one.

Functional testers can not be used to assess the accuracy of measured parameters of Model 960 Series.

A self-check device is included for temperature module which is used to check the temperature module during start up as well as once in a hour. If any problem is reported during this routine, stop using the unit and contact the local Medicaid Service Agent. Under normal condition, the temperature module takes approx. 60 secs to reach the final steady - state temperature.

DETAILED OPERATING INSTRUCTIONS

5.14 SETUP

Alarm Volume

To change the Alarm volume:

- Press **SETUP** followed by **SLCT** to select "ALA VOL" option.
- Use **▲** or **▼** to increase or decrease the alarm volume.

The volume increases to a maximum of five bars while decreases to a minimum of one bar.

Contrast

To adjust the screen contrast:

- Press **SETUP** followed by **SLCT** until "CONTRAST" option is selected.
- Use **▲** or **▼** to increase or decrease the contrast level.

Patient Type Setting

The default power-on setting from the factory is for adult patients. To change the Model 960 Series, from the adult to the neonatal setting.

- Press **SETUP** followed by **SLCT** until "PATIENT" option is selected.
- Use **▲** or **▼** to change the patient type between Adult and Neonate.

WARNING: You must select correct mode especially for neonate patients (refer to the PATIENT TYPE settings). Measurement under wrong mode may endanger patient because high adult blood pressure is not suitable for neonates. Before starting a measurement, verify that you have selected a measurement mode appropriate for your patient (adult, neonate).

Language

The Model 960 Series supports six different languages: English (default), Portuguese, Spanish, Dutch, Italian and French.

To change the Language:

- Press **SETUP** followed by **SLCT** until "LANGUAGE" option is selected.
- Use **▲** or **▼** to change to the desired language.

DETAILED OPERATING INSTRUCTIONS



Figure 11: Alarm Volume, Contrast, Patient Type, Language Settings

Date

The Model 960 Series shows the date in the format shown below:

Eg; 14: MAR: 06

To change the date:

- Press **SETUP** followed by **NEXT**, then press **SLCT** to select the date.
- Use **▲** or **▼** to change the date.
- Press **SLCT** again to highlight the month.
- Use **▲** or **▼** to change the month.
- Press **SLCT** again to highlight the year.
- Use **▲** or **▼** to change the year.

Time

The Model 960 Series has a 24 Hr Time format shown below

hh:mm:ss

To change the time:

- Press **SETUP** followed by **NEXT**, then press **SLCT** until the hour is selected, and then
- Use **▲** or **▼** to change the hour.
- Press **SLCT** again to highlight the minutes.
- Use **▲** or **▼** to change the minutes.
- Press **SLCT** again to highlight the seconds.
- Use **▲** or **▼** to change the seconds.

DETAILED OPERATING INSTRUCTIONS



Figure 12: Date, Time, Print and Power Save Mode Settings

Printer Mode

This feature is used to set the printer time interval. Default Printer mode is always manual. Print can be obtained in following time intervals i.e. 1, 2, 3, 5, 10, 15, 30 min respectively.

To change the time interval:

- Press **SETUP** followed by **NEXT**, then press **SLCT** until "PRINT MODE" option is selected.
- Use **▲** or **▼** to change the time interval.

Power Save Mode

When the Power Save Mode is activated the unit automatically turns the LCD Backlight "OFF" after 2 minutes. When any soft key on the unit is pressed or there is any Alarm condition, the Backlight comes on once again. The unit will not enter the Power Save Mode during an Alarm condition.

To select the Power Save Mode:

- Press **SETUP** followed by **NEXT**, then press **SLCT** until "POWER SAVE" option is selected.
- Use **▲** or **▼** to turn OFF or ON.

Temperature Scale

To change the temperature scales between Fahrenheit and Centigrade:

- Press **SETUP** followed by **NEXT**, then press **TEMP**.

The temperature display on the LCD will change between C (centigrade) and F (fahrenheit).

DETAILED OPERATING INSTRUCTIONS

5.15 PLETH / BLIP VIEW

To change from the Pleth to Blip View:

- Press **SETUP** followed by **BLIP**.



Figure 13: Pleth View



Figure 14: Blip View

5.16 TREND

The Model 960 Series can display tabular and graphical trends for SpO₂, BPM, Systolic, Diastolic, Mean, Temperature, Date, Time. The trend data is stored at 1minute interval. The Model 960 Series stores up to 24 hours of trend data.

Tabular Format

The tabular trend displays the Date, Time, SpO₂, BPM, Systolic, Diastolic, Mean and temperature values.

To view the trend data in the tabular format:

- Press **TREND**.
- Use **▲** and **▼** keys to scroll the data.

When the trends are displayed in tabular form, the most recent readings are at the top of the table.

A lower dot eg; ". " is visible next to a parameter value which crosses the lower alarm limits.

A higher dot eg; ". " is visible next to a parameter value which crosses the upper alarm limits.

DETAILED OPERATING INSTRUCTIONS

TIME	SPO2	BPM	SYS	DIA	MEAN	TEMP
12:34	97	97	137	85	182	26.4
12:35	97	97	137	85	182	26.4
12:32	97	97	137	85	182	26.4
12:31	97	97	137	85	182	26.4

SPO2 NIBP TEMP EXIT BACK

Figure 15: Tabular Trend

Graphical Format :

The graphical trend displays the SpO₂, BPM, Systolic, Diastolic, Mean, Temperature, Date, Time and Interval.

To view the SpO₂ and BPM Trend in graphical format:

- Press **TREND** followed by **SPO2** .
- Use **▲** and **▼** keys to move the cursor.
- Press **INTER** to view the 30 min, 1Hr, 2Hr, 6Hr, 12 Hr or the 24 Hr trend values.



Figure 16: SpO₂ and BPM Graphical Trend

To view the **SYSTOLIC** and **DIASTOLIC** trend in graphical format:

- Press **TREND** followed by **NIBP** .
- Use **▲** and **▼** keys to move the cursor.
- Press **INTER** to view the 30 min, 1Hr, 2Hr, 6Hr, 12 Hr or the 24 Hr trend values.

DETAILED OPERATING INSTRUCTIONS



Figure 17: Systolic and Diastolic Graphical Trend

To view the **MEAN** and **BPM** in graphical format:

- Press **TREND** followed by **NIBP**, and then **press MEAN**.
- Use **▲** and **▼** keys to move the cursor.
- Press **INTER** to view the 30 min, 1Hr, 2Hr, 6Hr, 12 Hr or the 24 Hr trend values.



Figure 18: Mean and BPM Graphical Trend

To view the **TEMPERATURE** and **BPM** in graphical format:

- Press **TREND** followed by **TEMP**.
- Use **▲** and **▼** keys to move the cursor.
- Press **INTER** to view the 30 min, 1Hr, 2Hr, 6Hr, 12 Hr or the 24 Hr trend values.

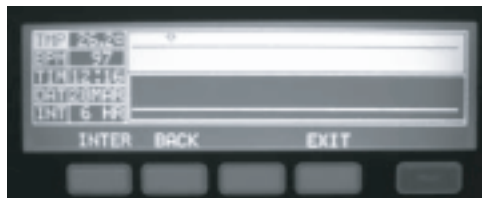

Figure 19: Temperature and BPM Graphical Trend

DETAILED OPERATING INSTRUCTIONS

When the trends are displayed in Graphical form, the most recent readings are on the left side of the graph. The values of the parameters at the cursor are indicated on the left side of the LCD display (Fig. 16, 17, 18, 19).

Trend Delete

When the Model 960 Series is turned ON, an option to "Clear previous Trend?" is displayed.

To clear the previous trend data:

- Press ^{YES} .

To retain the previous trend data:

- Press ^{NO} .

NOTE: If no choice is made then the trend data is retained and the monitor automatically proceeds to the monitoring mode.

5.17 NIBP CYCLE TIME

The NIBP cycle time and initial inflation pressure can also be adjusted.

To change the Cycle Time:

- Press ^{CYCLE} followed by ^{SLCT} to select the "CYCLE TIME" option.
- Use or keys to change the time interval to OFF, 1, 3, 5, 10, 15, 30, 60 or 90 minutes.

NOTE: Pressing the ^{AUTO} will change the cycle time to 5 min.

NOTE: Pressing the ^{MANUAL} will change the NIBP to Manual mode.

To change the Initial Inflation Pressure:

- Press ^{CYCLE} followed by ^{SLCT} until the "INITIAL INFLATE" option is selected.
- Use or keys to change the pressure between 120 mmHg to 280 mmHg when in the Adult mode or between 60 mmHg to 140 mmHg when in the Neonate mode.
- Press ^{DFLT} to change the initial inflate value to 160 mmHg in the Adult mode and to 90 mmHg if in the Neonate mode.

DETAILED OPERATING INSTRUCTIONS

5.19 ANALOG OUTPUT (OPTIONAL FEATURE)

The ANALOG OUTPUT option provides the capability to produce variable calibrating voltages to calibrate instruments such as a chart recorder. Refer to the "Analog Outputs" heading of Data Port Protocol for a more thorough explanation of these settings.

5.20 DEFAULT SETTINGS

The Model 960 Series is shipped with factory default settings (Refer to Table 2 and Table 3).

NOTE: Factory default settings are constants that cannot be changed without re-compiling software.

Table 2: Factory Default Settings (Adult)

Monitoring Mode	Adult
%SpO ₂ Lower Alarm Limit	85%
%SpO ₂ Upper Alarm Limit	100%
Pulse Rate Lower Alarm Limit	40 beats per minute
Pulse Rate Upper Alarm Limit	170 beats per minute
Systolic Lower Alarm Limit	70 mmHg
Systolic Upper Alarm Limit	200 mmHg
Diastolic Lower Alarm Limit	50 mmHg
Diastolic Upper Alarm Limit	160 mmHg
Mean Lower Alarm Limit	60 mmHg
Mean Upper Alarm Limit	180 mmHg
Initial Inflate Pressure	160 mmHg
Temperature Lower Alarm Limit	29°C (84.2°F)
Temperature Upper Alarm Limit	37°C (98.6°F)
Alarm Silence Duration	60 seconds
Alarm Volume	75 dB (A) peak at 1 meter (volume setting of 5)
Data Port Baud Rate	9600
Data Port Protocol	ASCII
Display Contrast	Midrange (Approx.)
Display Format	SpO ₂ , BPM and Temperature values on the LCD display. Systolic, Diastolic and Mean values on the 7-segment LED display.
Pulse Beep Volume	72 dB(A) at 1 meter (volume setting of 4)
Trend Display	%SpO ₂ , Pulse Rate, Systolic, Diastolic, Mean, Temp, Date and Time.
Print Mode	Manual
Initial Inflate	Off

DETAILED OPERATING INSTRUCTIONS

5.19 ANALOG OUTPUT (OPTIONAL FEATURE)

The ANALOG OUTPUT option provides the capability to produce variable calibrating voltages to calibrate instruments such as a chart recorder. Refer to the "Analog Outputs" heading of Data Port Protocol for a more thorough explanation of these settings.

5.20 DEFAULT SETTINGS

The Model 960 Series is shipped with factory default settings (Refer to Table 2 and Table 3).

NOTE: Factory default settings are constants that cannot be changed without re-compiling software.

Table 2: Factory Default Settings (Adult)

Monitoring Mode	Adult
%SpO ₂ Lower Alarm Limit	85%
%SpO ₂ Upper Alarm Limit	100%
Pulse Rate Lower Alarm Limit	40 beats per minute
Pulse Rate Upper Alarm Limit	170 beats per minute
Systolic Lower Alarm Limit	70 mmHg
Systolic Upper Alarm Limit	200 mmHg
Diastolic Lower Alarm Limit	50 mmHg
Diastolic Upper Alarm Limit	160 mmHg
Mean Lower Alarm Limit	60 mmHg
Mean Upper Alarm Limit	180 mmHg
Initial Inflate Pressure	160 mmHg
Temperature Lower Alarm Limit	29°C (84.2°F)
Temperature Upper Alarm Limit	37°C (98.6°F)
Alarm Silence Duration	60 seconds
Alarm Volume	75 dB (A) peak at 1 meter (volume setting of 5)
Data Port Baud Rate	9600
Data Port Protocol	ASCII
Display Contrast	Midrange (Approx.)
Display Format	SpO ₂ , BPM and Temperature values on the LCD display. Systolic, Diastolic and Mean values on the 7-segment LED display.
Pulse Beep Volume	72 dB(A) at 1 meter (volume setting of 4)
Trend Display	%SpO ₂ , Pulse Rate, Systolic, Diastolic, Mean, Temp, Date and Time.
Print Mode	Manual
Initial Inflate	Off

DETAILED OPERATING INSTRUCTIONS

Table 3: Factory Default Settings (Neonate)

Monitoring Mode	Neonate
%SpO ₂ Lower Alarm Limit	80%
%SpO ₂ Upper Alarm Limit	95%
Pulse Rate Lower Alarm Limit	90 beats per minute
Pulse Rate Upper Alarm Limit	190 beats per minute
Systolic Lower Alarm Limit	60 mmHg
Systolic Upper Alarm Limit	110 mmHg
Diastolic Lower Alarm Limit	30 mmHg
Diastolic Upper Alarm Limit	70 mmHg
Mean Lower Alarm Limit	40 mmHg
Mean Upper Alarm Limit	90 mmHg
Initial Inflate Pressure	90 mmHg
Temperature Lower Alarm Limit	29°C (84.2°F)
Temperature Upper Alarm Limit	37°C (98.6°F)
Alarm Silence Duration	60 seconds
Alarm Volume	75 dB (A) peak at 1 meter (volume setting of 5)
Data Port Baud Rate	9600
Data Port Protocol	ASCII
Display Contrast	Midrange (Approx.)
Display Format	SpO ₂ , BPM and Temperature values on the LCD display. Systolic, Diastolic and Mean values on the 7-segment LED display.
Pulse Beep Volume	72 dB(A) at 1 meter (volume setting of 4)
Trend Display	%SpO ₂ , Pulse Rate, Systolic, Diastolic, Mean, Temp, Date and Time.
Print Mode	Manual
Initial Inflate	Off

DETAILED OPERATING INSTRUCTIONS

5.21 BATTERY OPERATION

The Model 960 Series has an internal battery that may be used to power the monitor during mobile application or when AC power is not available. A new, fully charged battery will provide up to 2 hours of monitoring time under the following conditions: no audible alarms sound, backlight Off, and no analog or serial output devices attached.

NOTE: Whenever the monitor is connected to AC power, the battery is being charged. Therefore, it is recommended that the monitor remains connected to AC power when not in use. This will make available a fully charged battery for use at any time.

Before attempting to turn on the monitor, in which the battery charge has been depleted, plug the MONITOR into an AC outlet to allow the battery to charge for a few minutes. The monitor may then be powered on.

Low Battery Indicator

The red LED for Battery Low Indication will illuminate when the battery is near depletion, prompting the user to suspend operation of the unit and recharge/change the battery. Also the Battery symbol in the LCD display will blink and a Medium-Priority alarm will sound. The monitor will power off shortly after Battery Low Indication.

If the monitor is not connected to AC power within approximately 15 minutes, it will shut down.

NOTE: As the battery is used and recharged over a period of time, the amount of time between the onset of the low battery indicator and the instrument shut-off may become shorter. It is recommended that qualified service personnel replace the internal battery every 18 months.

CAUTION: If the Model 960 Series is to be stored for a period of 3 months or longer, notify service personnel to remove the battery from the monitor prior to storage. Recharge the battery when it has not been charged for 2 or more months.

5.22 DISPOSAL OF DEVICE COMPONENTS

CAUTION: Follow local governing ordinances and recycling instructions regarding disposal or recycling of device components, including batteries.

DETAILED OPERATING INSTRUCTIONS

5.23 PERFORMANCE CONSIDERATIONS

Impact of Patient Conditions on Monitor Readings

Certain patient conditions can affect the measurements of the Model 960 Series and cause the loss of the pulse signal.

WARNING: Pulse oximetry readings and pulse signals can be affected by certain ambient environmental conditions, sensor application errors, and certain patient conditions.

Inaccurate measurements can be caused by:

- Prolonged patient movement
- Venous pulsations
- Intravascular dyes, such as indocyanine green or methylene blue
- Significant levels of dysfunctional hemoglobin
- Defibrillation

Ambient environmental conditions and sensor application errors, which can affect pulse oximetry readings, are discussed in the Sensors section of this manual and in the sensor directions for use.

The effects of electromagnetic interference on oximetry readings are discussed in the Troubleshooting and Maintenance section of this manual.



Chapter 6: TROUBLESHOOTING AND MAINTENANCE

Troubleshooting

Status Messages

Suggested Corrective Actions

EMI (Electromagnetic Interference)

Obtaining Technical Assistance

Maintenance

6.1 TROUBLESHOOTING

WARNING: If you are uncertain about the accuracy of any measurement, check the patient's vital signs by alternate means; then make sure the monitor is functioning correctly.

WARNING: The cover should be removed only by qualified and trained service personnel. There are no user-serviceable parts inside.

Error Codes

When the Model 960 Series detects an error condition, it will display the letters "Err" in the seven segment LED display for Systolic followed by an error code in the seven segment LED display for Mean.

When an error code is displayed, turn the instrument off and back on again. If the error code reappears, record it and notify service personnel.

Error codes and their implications are listed in Table 4.

Table 4: Error Codes and Messages

Error Code	Error	Implications
001	POX Error	Error in the POX module. Unit enters monitoring mode but SpO ₂ and BPM values will not be measured.
002	NIBP Communication Error	Error in the NIBP module. Units enters monitoring mode but Systolic, Diastolic and Mean values will not be measured.
003	Slave Communication Error	Unit does not operate and continuously displays this error. Contact Medicaid Service center.
004	ADC Error	Unit does not operate and continuously displays this error. Contact Medicaid Service center.
005	Check Lithium Battery	Unit will operate, but Date and Time values will not update.
006	Check Trend Memory Chip	Unit will operate, but Trend does not update.
007	Check Internal Memory	Unit will not operate.

TROUBLESHOOTING AND MAINTENANCE

6.2 STATUS MESSAGES

SpO₂ Messages

Table 5: SpO₂ Messages

Message	Reason	Action
POX Error	SpO ₂ module is not communicating properly with the monitor.	Power the unit off and turn it on again. If problem persists contact Medicaid service center.
No Sensor	Sensor is not connected to the Model 960 Series.	Plug the sensor into the monitor.
No Finger	Sensor may not be connected to the patient.	Check patient connection.
No Pulse	No detectable pulse is measured.	Check patient connection and patient status.
Searching	Searching for a Pulse (approx 30 seconds after which "No Pulse" message is displayed).	Change to site where pulse is stronger. Change or readjust sensor if loose.
Artifact	Interference due to patient movement or ambient light.	Minimize the room light and decrease patient movement. Check sensor.
HIGH SpO ₂ , BPM	Higher alarm limits have been violated.	Check patient status.
LOW SpO ₂ , BPM	Lower alarm limits have been violated.	Check patient status.

NIBP Messages

Table 6: NIBP Messages

Message	Reason	Action
Weak or no oscillometric signal	Weak or No signal has been received by the NIBP module.	Check that the cuff is in the correct position. Check the patient. Check that the cuff is properly tightened. Check that there is no excessive clothing between the arm and the cuff. Check that the correct size cuff is being applied.

TROUBLESHOOTING AND MAINTENANCE

Message	Reason	Action
Artifact / erratic oscillometric signal.	The patient may have been moving too much.	<p>Decrease patient movement.</p> <p>Check that the cuff is in the correct position.</p> <p>Check that the correct size cuff is being applied.</p>
Exceeded retry count.	Measurements have been attempted but no reading were possible. The patient may have been moving too much.	<p>Check that the cuff is properly tightened.</p> <p>Check that the cuff is in the correct position.</p> <p>Check that the correct size cuff is being applied.</p> <p>Check that there is no excessive clothing between the arm and the cuff.</p>
Exceeded measured time limit.	Duration of NIBP reading has exceeded the safety limit. The patient may have been moving too much.	<p>Check that the cuff is properly tightened.</p> <p>Check that the cuff is in the correct position.</p> <p>Check that the correct size cuff is being applied.</p> <p>Check that there is no excessive clothing between the arm and the cuff.</p>
Pneumatic Blockage.	Cuff hose might be bent or pinched.	<p>Check that the hose has no sharp bends or is pinched.</p> <p>Check that the patient is not lying on the cuff.</p> <p>Check that the cuff is in the correct position.</p>

TROUBLESHOOTING AND MAINTENANCE

Message	Reason	Action
Terminated by user.	NIBP measurement has been terminated.	<p>Check the patient.</p> <p>Take another BP reading.</p>
Air Leak or Loose Cuff.	Cuff is not connected properly to the monitor or is loose.	<p>Check that the hose is connected to the system and the cuff.</p> <p>Check that the cuff is properly tightened.</p> <p>Check that the cuff is in the correct position.</p> <p>Check that the correct size cuff is being applied.</p> <p>Check that the cuff is not leaking air.</p> <p>Check that the hose connections are not damaged or loose.</p>
Safety Timeout.	NIBP module is malfunctioning.	<p>Check the patient.</p> <p>Check that the cuff is in the correct position.</p> <p>The patient may have been moving too much.</p> <p>Take another BP reading.</p> <p>If still not fixed, call Medicaid Service Center.</p>
High SYST, DIA, MEAN.	Higher alarm limits have been violated.	Check patient status.
Low SYST, DIA, MEAN.	Lower alarm limits have been violated.	Check patient status.

TROUBLESHOOTING AND MAINTENANCE

Printer Messages

Table 7: Printer Messages

Message	Reason	Action
Platen Release switch open.	This message appears when the Platen on the printer head has been removed or has snapped out.	Fix the platen back onto the printer head.
Waiting for NIBP Data.	Printer will not print during NIBP measurement.	Printer automatically prints after the NIBP reading has been measured.
No Data Available.	Printer does not print when no data is available.	Printer will only print when there is valid data.
Printer Busy.	This message is displayed when the print or the paper feed key is pressed while the printer is operational.	Wait till printer has finished the existing job and then press print again for another printout.
Printer Not Installed.	This message is displayed if the printer is not installed or the printer cable is snapped.	To install the printer, contact Mediaid Service Center.
No Paper.	This message appears if the printer runs out of paper during printing.	Load paper roll in the printer.

Temperature Messages

Table 8: Temperature Messages

Message	Reason	Action
High Temp	Higher alarm limits have been violated.	Check patient status.
Low Temp	Lower alarm limits have been violated.	Check patient status.

General Messages

Table 9: General Messages

Message	Reason	Action
Low Battery	Battery is near depletion.	Charge the battery immediately.
Trend Updating	This is displayed initially until the first data in the trend is updated which takes approximately 1 minute.	This is not displayed once the trend data is available.

6.3 SUGGESTED CORRECTIVE ACTIONS

If you experience a problem while using the Model 960 unit and are unable to correct it, contact Mediaid Inc. or the Mediaid local authorized distributor/service center. The Mediaid service manual, which is for use by qualified service personnel, provides additional troubleshooting information.

Following is a list of possible erroneous conditions and suggestions for correcting them.

1. There is no response to the POWER ON/OFF Key.
 - If operating on AC power, the fuse at AC mains (located at power Input module of Model 960 unit) may have blown. Notify service personnel to check and, if necessary replace the fuse.
 - If operating on battery power, the battery may be discharged. If the battery is discharged, notify service personnel to charge or replace the battery.
2. One or more display elements or indicators do not light during the power-on self-test.
 - Do not use the Model 960 unit, contact Mediaid Inc. or the Mediaid local authorized distributor/service center.
3. The Monitor is operating on battery power, even though it is connected to AC.
 - Make sure that the power cord is properly connected to the Model 960 unit.
 - Check to see if power is available to other equipment on the same AC circuit.
 - The fuse at AC mains (located at power Input module of Model 960 unit) may have blown. Notify service personnel to check and, if necessary replace the fuse.
4. The SEARCHING message is displayed for more than 30 seconds (before any measurements are taken).
 - Check the sensor directions for use to determine if an appropriate sensor is being used and it is applied properly. Check sensor and sensor cable connections. Test the sensor on someone else. Try another sensor or sensor cable.
 - Excessive patient movement may be preventing the Model 960 unit from tracking the pulse. Keep the patient still, if possible. Verify that the sensor is securely applied, and replace it if necessary. Change the sensor site. Use a type of sensor that tolerates more patient movement; for example, an adhesive sensor OR Tape-On Finger Sensor.
 - The sensor may be too tight, there may be excessive ambient light, or the sensor may be on an extremity with a blood pressure cuff, arterial catheter, or intravascular line. Reposition sensor, as necessary.

TROUBLESHOOTING AND MAINTENANCE

- Excessive environmental motion or electromagnetic interference may be preventing the Model 960 unit from tracking the pulse. Remove the source of interference or try to stabilize the environment, or do both.

5. The SEARCHING Indicator lights after successful measurements have been made.

- Check the patient.
- Perfusion may be too low for the Model 960 unit to track the pulse. Test the instrument on someone else. Change the sensor site. Try another type of sensor.
- Prolonged patient movement may be preventing the Model 960 unit from tracking the pulse. Verify that the sensor is securely applied and replace it if necessary. Change the sensor site. Use a type of sensor that tolerates more patient movement; for example, an adhesive sensor or Tape-On Finger Sensor.
- The sensor may be too tight, there may be excessive ambient light, or the sensor may be on an extremity with a blood pressure cuff, arterial catheter, or intravascular line. Reposition sensor, as necessary.
- Excessive environmental motion or electromagnetic interference may be preventing the Model 960 unit from tracking the pulse. Remove the source of interference to try to stabilize the environment, or do both.

Other physiological conditions or medical procedures that may interfere with the monitor's measurements include dysfunctional hemoglobin, arterial dyes, and dark pigment.

6.4 EMI (ELECTROMAGNETIC INTERFERENCE)

CAUTION: This device has been tested and found to comply with the limits for medical devices to the IEC 60601-1-2:2001, Medical Device Directive 93/42 EEC. These limits are designed to provide reasonable protection against harmful interference in a typical medical installation.

However, because of the proliferation of radio-frequency transmitting equipment and other sources of electrical noise in healthcare environments (for example, electro surgical units, cellular phones, mobile two-way radios, electrical appliances, and high-definition television), it is possible that high level of such interference due to close proximity or strength of a source may result in disruption of performance of this device.

The Model 960 Series is not designed for use in environments in which the pulse can be obscured by electromagnetic interference. During such interference, measurements may seem inappropriate or monitor may not seem to operate correctly.

TROUBLESHOOTING AND MAINTENANCE

Erratic readings, cessation of operation, or other incorrect functioning may evidence disruption. If this occurs, the site of use should be surveyed to determine the source of this disruption, and the following actions taken to eliminate the source:

- Turn equipment in the vicinity off and on to isolate the offending equipment.
- Reorient or relocate the interfering equipment.
- Increase the separation between the interfering equipment and the Model 960 Series monitor.

The Model 960 Series generates, uses, and can radiate radio frequency energy and, if not installed and used in accordance with these instructions, may cause harmful interference with other devices in the vicinity.

If assistance is required, contact Mediaid Inc. or the Mediaid local authorized distributor/service center.

6.5 OBTAINING TECHNICAL ASSISTANCE

For technical information and assistance, or to order parts or a service manual, contact Mediaid Inc. or the Mediaid local authorized distributor/service center. The service manual includes block diagrams and a parts list required by qualified personnel when servicing the Model 960 Series.

When calling Mediaid Technical Services Department or your local Mediaid representative, you may be asked to tell the representative the software version number of Model 960 Series.

The software version appears in the monitor display each time the monitor is switched on. Write the number down and have it available whenever requesting technical assistance.

Returning the Model 960 Series

Contact Mediaid Inc. or the Mediaid local authorized distributor / service center, for shipping instructions including a "Return Authorization Number (RAN)". Pack the model in its original shipping carton. If the original carton is not available, use a suitable carton with appropriate packing material to protect it during shipping.

Return the model by any shipping method that provides proof of delivery.

TROUBLESHOOTING AND MAINTENANCE

6.6 MAINTENANCE

Service

WARNING: The cover should be removed only by qualified and trained service personnel. There are no user-serviceable parts inside.

The Model 960 Series requires no calibration

The battery should be replaced at least every 12 months. Refer to the Model 960 Series service manual for the battery changing procedure.

If service is necessary, contact Medaid Inc. or the Medaid local authorized distributor/service center.

Periodic Safety Checks

It is recommended that the following checks be performed every 12 months:

- Inspect the equipment for mechanical and functional damage.
- Inspect the relevant safety labels for legibility.

Performance Verification

If the monitor has been visibly damaged or subjected to mechanical shock (for example, if dropped), qualified service personnel should perform the procedure mentioned in the service manual.

Cleaning

WARNING: Turn off the power and disconnect the line power cord before cleaning the monitor or the sensor/probe.

WARNING: Do not spray, pour or spill any liquid on the Model 960 Series, its accessories, connectors, switches, or openings in the chassis.

WARNING: In case of accidental wetting of the equipment ensure that the equipment is switched off and excess liquid/moisture is wiped off/cleaned. Allow the unit to dry before start using it again. In case of “not functioning” contact the local Medaid customer service center.

For surface-cleaning and disinfecting follow your institution's procedures or:

- The Model 960 Series may be surface-cleaned by the using a soft cloth dampened with either a commercial, nonabrasive cleaner or a solution of 70% alcohol in water, and lightly wiping the surfaces of the monitor
- The Model 960 Series may be disinfected using a soft cloth saturated with 10% chlorine bleach in tap water solution

Before attempting to clean a SpO₂ sensor, read the directions for use enclosed with the sensor. Each sensor model has cleaning instructions specific to the sensor.



Chapter 7:

SPECIFICATIONS AND PERFORMANCE REQUIREMENTS

Performance
Electrical
Environmental Conditions
Physical Characteristics
Compliance

7.1 PERFORMANCE

SpO₂ Performance Requirements

- Measurement Range: %SpO₂ : 1 – 100%
Pulse : 25 – 255 beats per minute (BPM)
- Resolution: %SpO₂ : 1%
Pulse : 1 BPM
- Accuracy: %SpO₂ : 100 – 70%, ± 2 digits
≤ 69%, Unspecified
Pulse : 25 – 255 BPM, ± 2 BPM

NIBP Performance Requirements

Adult

- Method of Measurement: Oscillometric
- Blood Pressure Range: Systolic: 40 mmHg to 260 mmHg
Diastolic: 20 mmHg to 200 mmHg
- Heart Rate Range: 40 to 200 BPM
- Cuff Deflate Rate: Deflation step size varies with heart rate,
cuff pressure and cuff volume
- Initial Inflation Pressure: 160 mmHg (default)
Variable from 120 to 280 mmHg

SPECIFICATIONS AND PERFORMANCE REQUIREMENTS

- Accuracy: ± 3 mmHg between 0 mmHg and 300 mmHg for operating conditions between 0°C and 50°C. Possible slight reduction in accuracy for temperatures above 50°C up to 60°C.
- Patient Safety: Internal operating software ensures that:
 - Maximum cuff inflation time is limited to 50 seconds.
 - Duration of blood pressure reading is limited to 130 seconds.Additional redundant safety circuitry oversees normal operation and will override to abort a reading if:
 - Cuff pressure exceeds 300 mmHg
 - The cuff has been inflated for 180 seconds.

Neonate (Weight less than 4 kg)

- Method of Measurement: Oscillometric
- Blood Pressure Range: 20 to 130 mmHg
- Heart Rate Range: 40 to 200 BPM
- Cuff Deflate Rate: Deflation step size varies with heart rate, cuff pressure and cuff volume.
- Initial Inflation Pressure: 90 mmHg (default)
Variable from 60 to 140 mmHg
- Minimum Hose Length: 3 meters
- Patient Safety: Internal operating software ensures that:
 - Maximum cuff inflation time is limited to 50 seconds.
 - Duration of a single blood pressure reading is limited to 75 seconds.Additional redundant safety circuitry oversees normal operation and will override to abort a reading if:
 - Cuff pressure exceeds 150 mmHg at any time.
 - The cuff has been inflated for 90 seconds.

SPECIFICATIONS AND PERFORMANCE REQUIREMENTS

Temperature Performance Requirements

- Connector Type: The temperature sensor cable connects with a 3 circuit 0.25 inch phone jack as a standard feature.
- Probe Type: YSI Compatible
- Scale: Selectable °C or °F
- Range: 23°C to 45°C or 73.4°F to 113°F
- Resolution: 0.1°C / 0.1°F
- Accuracy: ±0.1°C (25°C to 45°C) exclusive of probe errors
or
±0.2°F (77°F to 113°F) exclusive of probe errors

Printer Performance Requirements

- Print Method: In line thermal dot printing
- Thermal Paper: Thickness - 60 to 72 µm
Width - 57.5 mm
- Recommended Paper: TF 60 KS - E Nippon Paper
PDI50R Oji Paper

7.2 ELECTRICAL

AC Power

- Power Requirements: 100 – 230 VAC, 50/60 Hz
- Fuses: 2 Qty, 2.0 A, 250 volts, fast-blow, IEC (5 x 20 mm)

NOTE: Always use a 3 pin power cord with Proper Earthing Pin.

Battery

- Battery Type: Sealed Lead Acid
- No. of Batteries: 1
- Nominal Battery Voltage: 12 Volts DC
- Battery Capacity: 1.2 Amp-hour
- Minimum Battery Run Time: 2 hours in power save mode, no printing and NIBP running at 90 min interval; using new, fully charged battery.
- Battery Recharge Time: 16 hours maximum
- Battery Cutoff Voltage: Approx. 11 Volts DC
- Low Battery Warning Level: Approx. 11.5 Volts DC
- Time to Shutdown from Low Battery: 10 to 15 minutes

SPECIFICATIONS AND PERFORMANCE REQUIREMENTS

7.3 ENVIRONMENTAL CONDITIONS

Acceptable Conditions for Operating, Storage and Transport

- Operating Temperature: 0° C to 40° C (32°F to 104° F)
- Storage & Transport Temperature: -30° C to 65° C (-22°F to 149° F)
- Atmospheric Pressure: 770 to 282.45 mmHg or 1026 to 377 hPa
- Relative Humidity: 5 – 95% (non-condensing)

7.4 PHYSICAL CHARACTERISTICS

- Weight: 2.85 kgs. or 5.6 lbs. (without Accessories)
3.35 kgs. or 7.3 lbs. (with Accessories)
- Dimensions: 11.8 (L) x 8 (W) x 3.3 (H) inch
or
30 (L) x 20.3 (W) x 8.4 (H) cm

7.5 COMPLIANCE

- Emissions Compliance: EN55011, CISPR 11, GROUP 1, Class B
(Class A for Radiated Emission)
- Type of Protection: Class 1 (on AC power)
Internally powered (on battery power)
Type BF – Applied Part - SpO₂ sensor
Type BF-Defib proof Applied Part - NIBP cuff.
- Degree of Protection Enclosure:
Degree of Ingress Protection from Solids / Liquids: IPXI
- Mode of Operation: Continuous
- The equipment is designed to comply with the following additional industry standards of design and manufacture: ISO 13485:2003, ISO 9001:2000, ISO 14971:2000, MDD 93/42/EEC (serie CE) IEC 60601-1-2:2001, IEC 60601-1:1988, IEC 60601-1-4:1996, IEC 60601-2-30:1999, EN 1060-1:1996, EN 1060-3:1997 IEC 60601-2-49:2001, EN 12470-4:2000, ISO 9919:2005, ISO 14155-1:2003, ISO 14155-2:2003 for clinical study, ISO 10993-1:2003, EN 980:2003

Chapter 8:

DATA PORT PROTOCOL

Overview

Serial Data Transmission (Optional Feature)

Nurse Call (Optional Feature)

Analog Outputs (Optional Feature)

8.1 OVERVIEW

Serial and analog data can be communicated through the data port to a peripheral device. Analog output of oxygen saturation, pulse rate, NIBP measurements and temperature are each transmitted on a scale of 0.0 to 1.0 V. Serial output of oxygen saturation pulse rate, NIBP measurements and temperature are transmitted continuously. For tests regarding data transmission and the data port, please refer to the Test section.

Table 10 : Data Port Pinouts Table

Pin No.	Description
1	Analog - SpO ₂
2	RX RS 232 (system Rx)
3	TX RS 232 (system Tx)
4	Analog - Systolic
5	COM I GND
6	Nurse Call Common
7	Nurse Call - NO
8	Nurse Call - NC
9	Earth
10	Analog - BPM
11	Analog - Perfusion
12	Analog - Diastolic
13	Analog - Mean
14	Analog - Temp
15	COM I GND

DATA PORT PROTOCOL

8.2 SERIAL DATA TRANSMISSION (OPTIONAL FEATURE)

- Serial data can be transmitted with a Mediaid Serial Cable.
- Transmission speed is 9600 baud.
- The data field is 8 bits, one stop bit, no parity.
- The data packet output by the Model 960 Series is comprised one packet of data. Sent in the following order: It contains Date, month, hour, minute, SpO₂, BPM, systolic lower byte, systolic upper byte, diastolic lower byte, diastolic upper byte, mean lower byte, mean upper byte, temperature lower byte, temperature upper byte, Year and checksum.

Trend Request - 0xD5

**Table 11: Serial Data Communication Format
(Model 960 Series to system)**

Byte	Specification
1	A
2	C
3	K
4	Trend-add-lower
5	Trend-add-higher
6	Trend over flow
7	Check sum

Trend over flow byte (status)

Table 12: Bit Specification of Status Byte

Byte	Specification
BIT 0	1- Trend over flow 0- No over flow
BIT 1	X
BIT 2	X
BIT 3	X
BIT 4	X
BIT 5	X
BIT 6	X
BIT 7	X

DATA PORT PROTOCOL

After receiving the acknowledgment command the following information can be extracted.

Table 13: Offline Trend Data Command Format

Byte	Specification
Byte 0	Date
Byte 1	Month
Byte 2	Hour
Byte 3	Minute
Byte 4	SPO ₂
Byte 5	BPM
Byte 6	SYS - lower
Byte 7	SYS - higher
Byte 8	DIA - lower
Byte 9	DIA - higher
Byte 10	Mean - lower
Byte 11	Mean - higher
Byte 12	Temp - lower
Byte 13	Temp - higher
Byte 14	Year
Byte 15	Check sum

OXE5 – Request next byte

OXE7 – Request previous byte

8.3 NURSE CALL (OPTIONAL FEATURE)

WARNING: The nurse call feature should not be used as the primary source of alarm notification. The audible and visual alarms of the monitor, used in conjunction with clinical signs and symptoms, are the primary source for notifying medical personnel that an alarm condition exists.

The solid-state relay based nurse call function is available when the monitor is operating either on AC power or when powered by battery. The remote location will be signaled anytime there is an audible alarm. If the audible alarm has been turned off, or silenced, the nurse call alarm is also turned off.

DATA PORT PROTOCOL

8.4 ANALOG OUTPUTS (OPTIONAL FEATURE)

The Model 960 Series data port also provides analog voltage outputs between pins 1, 10, 12, 4, 13, 11, 14 and ground (pins 5 or 15), which can be used to calibrate instruments such as a chart recorder.

Analog outputs are as follows: 0% Scale – 0.000 V, 50% Scale – 0.500 V, 100% Scale – 1.000 V. The voltage represents a specific measured parameter's current value. The voltage Differential varies over its full range of values, as indicated in Table 14.

Table 14: Analog Pinouts

Pins	Parameter	Parameter Range
1	% SpO ₂	0-100%
10	Pulse Rate	25-255
12	Diastolic	20-200
4	Systolic	40-260
13	Mean	30-230
14	Temp	23°C to 45°C (73.4°F to 113°F)
11	Perfusion	0-1024

For example, as the current value of %SpO₂ varies from 0 to 100%, the voltage from pin 1 to ground (pin 5 or pin 15) would vary from 0 to 1 volt. A voltage of 0.94 volts indicates a current %SpO₂ value of 94. Similarly for Systolic, Diastolic, Mean the same method is applied.

Similarly for temperature as the current value varies from 23°C to 45°C (73.4°F to 113°F), the voltage from pin 14 to ground (pin 5 or pin 15) would vary from 0 to 1 volt. A voltage of 0.54 volts indicates a current temperature value of 35°C (95°F).

Qualified service personnel using the procedure described in the Model 960 Series service manual can perform calibrations of the analog output and the attached device.

Chapter 9:

PRINCIPLES OF OPERATION

Oximetry Overview

9.1 OXIMETRY OVERVIEW

Pulse oximeters provide a spectrophotometric assessment of functional arterial Hemoglobin oxygenation (SpO_2). Pulse oximetry is based on the following two principles. First, hemoglobin (Hb) and oxygenated hemoglobin (HbO_2) differ in their absorption of red and infrared light. Second, the volume of arterial blood in tissue (and therefore, light absorption by the hemoglobin) changes during the pulse. Therefore, a pulse oximeter passes red and infrared light into an arteriolar bed, measures changes in light absorption, and determines SpO_2 .

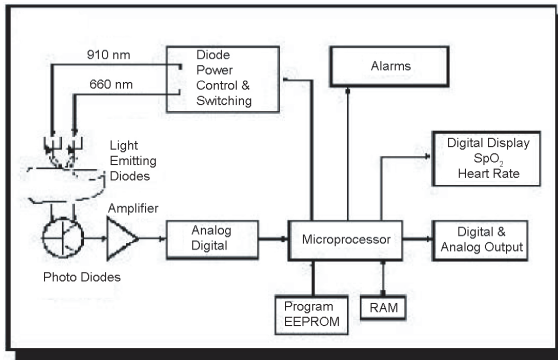

Figure 21: Principles of Pulse Oximetry

PRINCIPLES OF OPERATION

How Pulse Oximeters Work

Pulse oximeter sensors have red and infrared low voltage light-emitting diodes (LEDs) which serve as light sources. The emitted light is transmitted through the tissue, and then detected by the photodetector where it is then sent to the microprocessor of the pulse oximeter (Fig. 21). All constituents of the human body, venous and arterial blood and tissue absorb light (Fig. 22). The pulsating of arterial blood results in changes in the absorption due to added hemoglobin (Hb) and oxygenated hemoglobin (HbO₂) in the path of the light. Since (HbO₂) and (Hb) absorb light to varying degrees, this varying absorption is translated into plethysmographic waveforms at both red and infrared wavelengths (Fig. 23). The relationship of red and infrared plethysmographic signal amplitude can be directly related to arterial oxygen saturation. For example, when the plethysmographic amplitude at 660nm and 910nm are equal and the ratio R/IR=1, the SpO₂ is approximately 85% (Fig. 24).

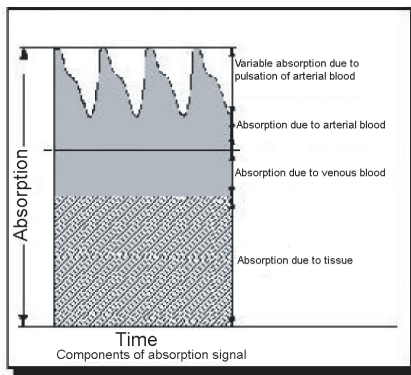

Figure 22: Light Absorption

PRINCIPLES OF OPERATION

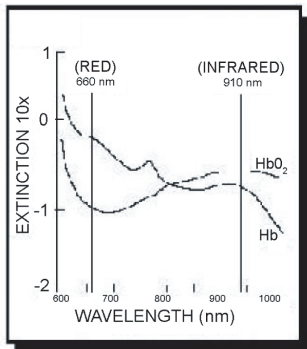

FIGURE 23: Varying Absorption by (HbO₂) & (Hb)

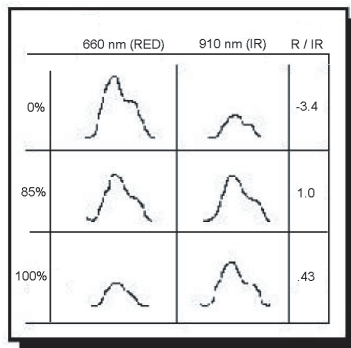

Figure 24: Pleth Amplitude at 660nm & 910nm

Calibration of Pulse Oximeters

The light absorption by hemoglobin is wavelength dependent. Mediaid's red and infrared LED wavelengths are tightly controlled by testing each individual sensor. In addition, the LED intensity recorded at the detector is automatically adjusted for amplitude. This allows Mediaid vital signs monitor sensors to be used interchangeably without calibration.

Validation of Accuracy

Mediaid pulse oximeters and sensors are tested for accuracy at the Anesthesia Research Laboratory of the University of California Medical Center in San Francisco. Validation consists of inducing hypoxemia in healthy subjects and comparing pulse oximeter readings (SpO₂) to co-oximeter readings (SpO₂) using arterial samples. Figure 25 and Figure 26 compare results from a typical Mediaid pulse oximeter and a Competitor's pulse oximeter. Both instruments show a small bias and similar distribution of sampling points.

PRINCIPLES OF OPERATION

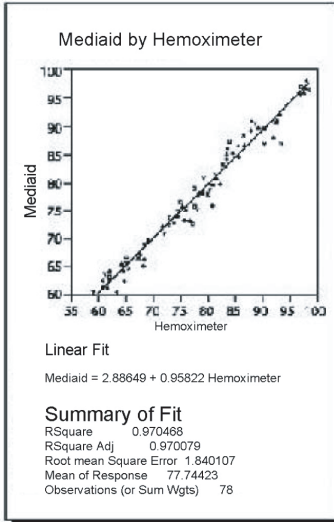

Figure 25: Mediaid by Hemoximeter

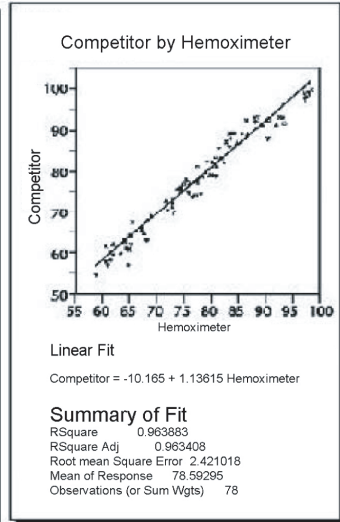

Figure 26: Competitor by Hemoximeter

Clinical Use of Pulse Oximetry

Pulse oximeters may be used in a variety of situations that call for monitoring oxygenation and pulse rates. Pulse oximeters increase patient safety by alerting the hospital staff to the onset of hypoxia during or following surgery. Oximeters confirm adequate oxygenation during mechanical ventilation. Physician and dental offices utilize pulse oximetry for spot checking respiratory status, as well as for monitoring during procedures that call for sedation. Truly, pulse oximetry is the fifth vital sign, essential to complete patient monitoring.

Chapter 10:

MEDIAID INC. WARRANTY

Warranty Information

Owner's Registration

Product Information

10.1 WARRANTY INFORMATION

Please Note: THIS PRODUCT IS MANUFACTURED AND SOLD BY MEDIAID INC. (HEREAFTER REFERRED TO AS MEDIAID) UNDER THE WARRANTIES SET FORTH BELOW.

Application of Warranty

This warranty covers only the Mediaid MONITOR Model 960 Series and accessories as indicated. It is not extended to the other products or components that the customer uses in conjunction with the Mediaid product. This warranty shall not apply if the manufacturer determines that the product has been damaged due to abuse, misuse, misapplication, accident, negligence, tampering or as a result of service or modification by any other person other than an authorized Mediaid service technician.

Opening of the sealed enclosure or altering the serial number will void warranty. Use of equipment contrary to or inconsistent with the User manual will also void the Warranty.

What is covered by this Warranty?

Mediaid warrants that the Mediaid product enclosed with this warranty will conform to the manufacturer's specifications, and shall be free from defects in workmanship and materials for a period of one (1) year from the date of original purchase. Items excluded from this one-year term are the batteries, sensor extension cables, sensors and other accessories.

What Mediaid will do to correct the problems?

Should your Mediaid product prove to be defective, contact Mediaid Inc. or the Mediaid local authorized distributor/service center for repairs. Please have your model and serial number available when calling.

Mediaid will then issue a "Return Authorization Number (RAN)". Return your instrument securely packaged in its original shipping carton (or equivalent packaging), include your Return Authorization Number.

Mediaid Inc. will repair any faulty workmanship and either repair or replace (at its option) any defective part with new or refurbished parts. For non-warranty repairs, the customer will be charged the current repair rate at the time of receipt by Mediaid and all transportation charges shall be customer's responsibility. Mediaid shall not be liable for any damages including, but not limited to, incidental damages, consequential damages or special damages. This Warranty does not cover any damage to the equipment during shipping, which shall be the sole responsibility of the transportation company.

MEDIAID INC. WARRANTY

Always read the User's Manual carefully: The information included in the User's Manual will assist the user in preventing equipment misuse and ensuring patient safety. Operation of the equipment in a manner contrary or inconsistent with the User's Manual will void the Warranty.

10.2 OWNER'S REGISTRATION

To assist Mediaid Inc. in serving you, please complete the warranty Registration Card that is included and return it to **MEDIAID INC., 17517 Fabrica way Suite H; Cerritos, CA 90703 USA. (Tel) 714-367-2848 (Fax) 714-367-2852 Website: www.mediaidinc.com**

NOTE: THERE ARE NO WARRANTIES, EXPRESS OR IMPLIED, WHICH EXTEND BEYOND THE WARRANTIES SET FORTH ABOVE. MEDIAID INC., MAKES NO WARRANTY OF MERCHANTABILITY OR FITNESS FOR A PARTICULAR PURPOSE WITH RESPECT TO THE PRODUCT OR PARTS THEREOF. THIS WARRANTY GIVES YOU SPECIFIC LEGAL RIGHTS. YOU MAY HAVE OTHER LEGAL RIGHTS, WHICH VARY FROM STATE TO STATE. MEDIAID INC., WILL NOT BE LIABLE TO THE USER FOR INCIDENTAL OR CONSEQUENTIAL DAMAGE OR LOSS ARISING OUT OF THE USER'S INABILITY TO USE THIS PRODUCT.

10.3 PRODUCT INFORMATION

To better assist customers, Mediaid Inc., recommends all users write down all pertinent product and warranty information.

Product # _____

Serial # _____

Software Version # _____

Warranty Expiration Date _____

WARRANTY REGISTRATION FORM

Please return to Medicaid Inc. / local distributor for validation

MEDIAID INC.

17517 Fabrica Way Suite H Cerritos, CA 90703 USA

(Tel) 714-367-2848 (Fax) 714-367-2852

Email: info@mediaidinc.com Website: www.mediaidinc.com

Model _____ Serial Number _____

Date of Purchase _____

Institution/Physician _____

Address _____

Contact Department _____

Telephone _____

Distributor _____ Phone _____

Comments _____

1007-60001-002

